

Raccord et accessoire de lavage HP

Chapitre 11

2025



Sommaire

01- FLEXIBLE DE LAVAGE EQUIPÉ	-----	05-09
02- ADAPTEUR LAVAGE HAUTE PRESSION	-----	10-34
03- PISTOLET DE LAVAGE	-----	35-45
04- LANCE DE LAVAGE	-----	46-56
05-BUSE ET ROTABUSE HAUTE PRESSION	-----	57-71
06- ENROULEUR AUTOMATIQUE	-----	72-81
07- COUPLEUR EAU HAUTE PRESSION	-----	82-87
08- RACCORD TOURNANT SOUS PRESSION	-----	88-93

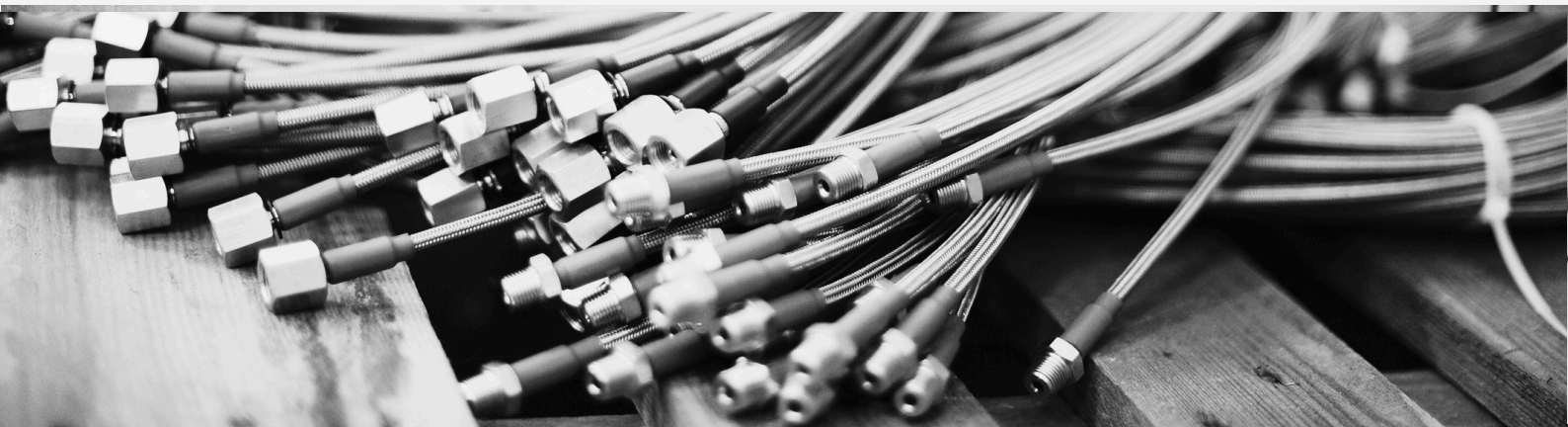

Sommaire

**09- ACCESSOIRES DE
LAVAGE**

94-101

**10- ACCESSOIRE DE
JARDINAGE**

102-109

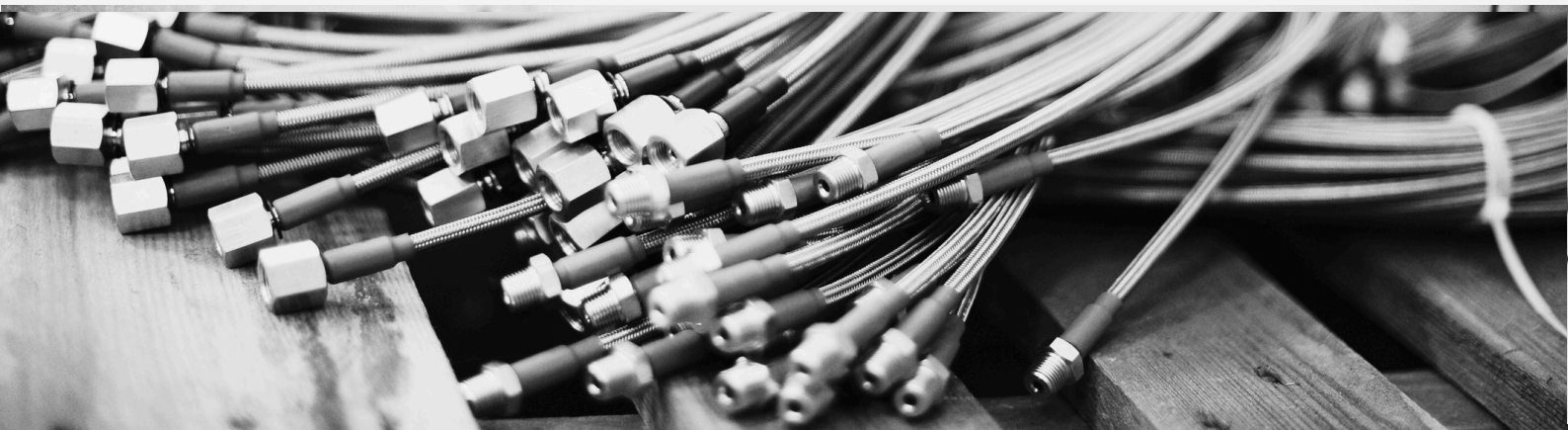

1- FLEXIBLE DE LAVAGE EQUIPÉ



Flexibles de lavage bleu DN08 – 400 bars équipés



Flexibles de lavage bleu DN08 – 400 bars équipés

Construction : caoutchouc synthétique, robe extérieure bleue

Renforcement : 2 tresses acier haute résistance (compact)

Poignée et cache écrou bleu (sauf rotatif écrou noir)

Utilisation : lavage et nettoyage haute pression

Diamètre extérieure du tuyau : 15mm

Température : -10°C à +155°C

Pression de service : 400 bars

Autre longueurs ou assemblage sur demande, raccords inox sur demande

Code	Référence	Tuyau	Raccord 1	Raccord 2	Longueur	Nb poignée	Pression de service	Poids
LONGUEUR 10M								
126489	LAVEUR 810C BLEU 2xK22 SS POIGNEE *	2SCL 8	FEM 22X150	FEM 22X150	10 M	0	400 bars	0
126495	LAVEUR 810C BLEU K22P K22 *	2SCL 8	FEM 22X150	FEM 22X150	10 M	1	400 bars	0
126488	LAVEUR 810C BLEU 2xK22P *	2SCL 8	FEM 22X150	FEM 22X150	10 M	2	400 bars	0
126493	LAVEUR 810C BLEU K22P K22P-TOURN *	2SCL 8	FEM 22X150	ROTATIF 22X150	10 M	2	400 bars	0
126492	LAVEUR 810C BLEU K22P KE10 *	2SCL 8	FEM 22X150	KE 10	10 M	1	400 bars	0
126494	LAVEUR 810C BLEU K22P KE11AR *	2SCL 8	FEM 22X150	KE 11 ROTATIF	10 M	1	400 bars	0
126491	LAVEUR 810C BLEU K22P KE11RLT *	2SCL 8	FEM 22X150	KE11 INOX ROTAT	10 M	1	400 bars	0
126496	LAVEUR 810C BLEU WF3/8P WF3/8 *	2SCL 8	FEM BSP 3/8	FEM BSP 3/8	10 M	1	400 bars	0
147088	LAVEUR 810C BLEU 2xWF3/8P *	2SCL 8	FEM BSP 3/8	FEM BSP 3/8	10 M	2	400 bars	0
147090	LAVEUR 810C BLEU WF3/8P WM3/8P *	2SCL 8	FEM BSP 3/8	MALE BSP 3/8	10 M	2	400 bars	0
147089	LAVEUR 810C BLEU 2xWM3/8P *	2SCL 8	MALE BSP 3/8	MALE BSP 3/8	10 M	2	400 bars	0
LONGUEUR 15M								
126522	LAVEUR 815C BLEU 2xK22P *	2SCL 8	FEM 22X150	FEM 22X150	15 M	2	400 bars	0
126520	LAVEUR 815C BLEU K22P 22P-TOURN *	2SCL 8	FEM 22X150	ROTATIF 22X150	15 M	2	400 bars	0
126525	LAVEUR 815C BLEU K22P KE10 *	2SCL 8	FEM 22X150	KE 10	15 M	1	400 bars	0
126521	LAVEUR 815C BLEU K22P KE11AR *	2SCL 8	FEM 22X150	KE 11 ROTATIF	15 M	1	400 bars	0
126524	LAVEUR 815C BLEU K22P KE11RLT *	2SCL 8	FEM 22X150	KE11 INOX ROTAT	15 M	1	400 bars	0
126526	LAVEUR 815C BLEU K22P+WF3/8 *	2SCL 8	FEM 22X150	FEM BSP 3/8	15 M	1	400 bars	0
147091	LAVEUR 815C BLEU 2xWF3/8P *	2SCL 8	FEM BSP 3/8	FEM BSP 3/8	15 M	2	400 bars	0
147092	LAVEUR 815C BLEU 2xWM3/8P *	2SCL 8	MALE BSP 3/8	MALE BSP 3/8	15 M	2	400 bars	0
LONGUEUR 20M								
126529	LAVEUR 820C BLEU 2xK22 SS POIGNEE *	2SCL 8	FEM 22X150	FEM 22X150	20 M	0	400 bars	0
147094	LAVEUR 820C BLEU K22P K22 *	2SCL 8	FEM 22X150	FEM 22X150	20 M	1	100 bars	0
126528	LAVEUR 820C BLEU 2xK22P *	2SCL 8	FEM 22X150	FEM 22X150	20 M	2	400 bars	0
126534	LAVEUR 820C BLEU K22P K22P-TOURN *	2SCL 8	FEM 22X150	ROTATIF 22X150	20 M	2	400 bars	0
126532	LAVEUR 820C BLEU K22P KE10 *	2SCL 8	FEM 22X150	KE 10	20 M	1	400 bars	0
126533	LAVEUR 820C BLEU K22P KE11RLT *	2SCL 8	FEM 22X150	KE11 INOX ROTAT	20 M	1	400 bars	0
126536	LAVEUR 820C BLEU K22P KE11AR *	2SCL 8	FEM 22X150	KE 11 ROTATIF	20 M	1	400 bars	0
130052	LAVEUR 820C BLEU K22P WF3/8 *	2SCL 8	FEM 22X150	FEM BSP 3/8	20 M	1	400 bars	0
147087	LAVEUR 820C BLEU 2xWF3/8P *	2SCL 8	FEM BSP 3/8	FEM BSP 3/8	20 M	2	400 bars	0
127583	LAVEUR 820C BLEU WF3/8P WM3/8P *	2SCL 8	FEM BSP 3/8	MALE BSP 3/8	20 M	2	400 bars	0
126531	LAVEUR 820C BLEU 2xWM3/8P *	2SCL 8	MALE BSP 3/8	MALE BSP 3/8	20 M	2	400 bars	0

Code	Référence	Tuyau	Raccord 1	Raccord 2	Longueur	Nb poignée	Pression de service	Poids
LONGUEUR 25M								
126487	LAVEUR 825C BLEU 2xK22 SANS POIGNEE*	2SCL 8	FEM 22X150	FEM 22X150	25 M	0	400 bars	0
126482	LAVEUR 825C BLEU 2xK22P *	2SCL 8	FEM 22X150	FEM 22X150	25 M	2	400 bars	0
126486	LAVEUR 825C BLEU K22P K22P-TOURN *	2SCL 8	FEM 22X150	ROTATIF 22X150	25 M	2	400 bars	0
128208	LAVEUR 825C BLEU K22P KE11AR *	2SCL 8	FEM 22X150	KE 11 ROTATIF	25 M	1	400 bars	0
LONGUEUR 30M								
126537	LAVEUR 830C BLEU 2xK22P *	2SCL 8	FEM 22X150	FEM 22X150	30 M	2	400 bars	0
LONGUEUR 40M								
075893	LAVEUR 840C BLEU 2xK22P *	2SCL 8	FEM 22X150	FEM 22X150	40 M	2	400 bars	0

Flexibles de lavage bleu DN06 – 210 bars équipés



Flexibles de lavage bleu DN06 – 210 bars équipés

Construction : caoutchouc synthétique, robe extérieure bleue

Renforcement : 1 tresse acier haute résistance (compact)

Poignée et cache écrou bleu (sauf rotatif écrou noir)

Utilisation : lavage et nettoyage haute pression

Diamètre extérieure du tuyau : 12mm

Température : -10°C à +155°C

Pression de service : 210 bars

Autre longueurs ou assemblage sur demande, raccords inox sur demande

Code	Référence	Tuyau	Raccord 1	Raccord 2	Longueur	Nb poignée	Pression de service	Poids
LONGUEUR 10M								
147096	LAVEUR 610C BLEU 2xK22 SS POIGNEE *	1SCL 6	FEM 22X150	FEM 22X150	10 M	0	210 bars	0
147095	LAVEUR 610C BLEU 2xK22P *	1SCL 6	FEM 22X150	FEM 22X150	10 M	2	210 bars	0
147099	LAVEUR 610C BLEU 22P K22P-TOURN *	1SCL 6	FEM 22X150	ROTATIF 22X150	10 M	2	210 bars	0
147097	LAVEUR 610C BLEU K22P KE10 *	1SCL 6	FEM 22X150	KE 10	10 M	1	210 bars	0
147105	LAVEUR 610C BLEU K22P KE10RLT *	1SCL 6	FEM 22X150	KE10 INOX ROTAT	10 M	1	210 bars	0
147106	LAVEUR 610C BLEU K22P KE11RLT *	1SCL 6	FEM 22X150	KE11 INOX ROTAT	10 M	1	210 bars	0
LONGUEUR 15M								
147112	LAVEUR 615C BLEU 2xK22 SS POIGNEE *	1SCL 6	FEM 22X150	FEM 22X150	15 M	0	210 bars	0
147111	LAVEUR 615C BLEU 2xK22P *	1SCL 6	FEM 22X150	FEM 22X150	15 M	2	210 bars	0
147122	LAVEUR 615C BLEU 22P K22P-TOURN *	1SCL 6	FEM 22X150	ROTATIF 22X150	15 M	2	210 bars	0
147113	LAVEUR 615C BLEU K22P KE10 *	1SCL 6	FEM 22X150	KE 10	15 M	1	210 bars	0
147114	LAVEUR 615C BLEU K22P KE10RLT *	1SCL 6	FEM 22X150	KE10 INOX ROTAT	15 M	1	210 bars	0
147116	LAVEUR 615C BLEU K22P KE11RLT *	1SCL 6	FEM 22X150	KE11 INOX ROTAT	15 M	1	210 bars	0
LONGUEUR 20M								
147117	LAVEUR 620C BLEU 2xK22P *	1SCL 6	FEM 22X150	FEM 22X150	20 M	2	210 bars	0
147121	LAVEUR 620C BLEU 22P K22P-TOURN *	1SCL 6	FEM 22X150	ROTATIF 22X150	20 M	2	210 bars	0
147118	LAVEUR 620C BLEU K22P KE10 *	1SCL 6	FEM 22X150	KE 10	20 M	1	210 bars	0
147119	LAVEUR 620C BLEU K22P KE10RLT *	1SCL 6	FEM 22X150	KE10 INOX ROTAT	20 M	1	210 bars	0
147120	LAVEUR 620C BLEU K22P KE11RLT *	1SCL 6	FEM 22X150	KE11 INOX ROTAT	20 M	1	210 bars	0

Flexibles de lavage gris DN08 – 400 bars équipés

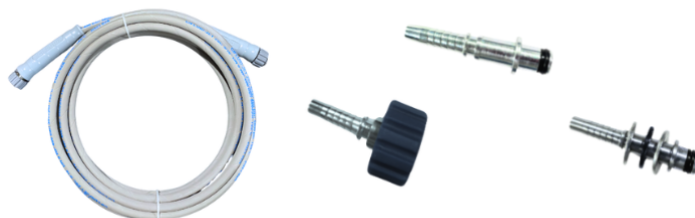

Flexibles de lavage gris DN08 – 400 bars équipés

Construction : caoutchouc synthétique, robe extérieure grise
Renforcement : 2 tresses acier haute résistance (compact)
Poignée grise ; cache écrou noir (sauf 21x150 cache écrou gris)
Utilisation : lavage et nettoyage haute pression
Diamètre extérieure du tuyau : 15mm
Température : -10°C à +155°C
Pression de service : 400 bars

Autre longueurs ou assemblage sur demande, raccords inox sur demande

Code	Référence	Tuyau	Raccord 1	Raccord 2	Longueur	Nb poignée	Pression de service	Poids
LONGUEUR 10M								
147152	LAVEUR 810C GRIS 2xK21 SS POIGNEE *	2SCG 8	FEM 21X150	FEM 21X150	10 M	0	400 bars	0
147151	LAVEUR 810C GRIS 2xK21P *	2SCG 8	FEM 21X150	FEM 21X150	10 M	2	400 bars	0
147153	LAVEUR 810C GRIS K21P K21P-TOURN *	2SCG 8	FEM 21X150	ROTATIF 21X150	10 M	2	400 bars	0
147154	LAVEUR 810C GRIS K21P KE10 *	2SCG 8	FEM 21X150	KE 10	10 M	1	400 bars	0
147147	LAVEUR 810C GRIS 2xK22 SS POIGNEE *	2SCG 8	FEM 22X150	FEM 22X150	10 M	0	400 bars	0
147149	LAVEUR 810C GRIS 2xK22P *	2SCG 8	FEM 22X150	FEM 22X150	10 M	2	400 bars	0
147150	LAVEUR 810C GRIS K22P K22P-TOURN *	2SCG 8	FEL 22X150	ROTATIF 22X150	10 M	2	400 bars	0
147156	LAVEUR 810C GRIS K22P KE10 *	2SCG 8	FEM 22X150	KE 10	10 M	1	400 bars	0
147228	LAVEUR 810C GRIS K22P KE11RLT *	2SCG 8	FEM 22X150	KE11 INOX ROTAT	10 M	1	400 bars	0
LONGUEUR 15M								
147232	LAVEUR 815C GRIS 2xK21P *	2SCG 8	FEM 21X150	FEM 21X150	15 M	2	400 bars	0
147231	LAVEUR 815C GRIS K21P 21P-TOURN *	2SCG 8	FEM 21X150	ROTATIF 21X150	15 M	2	400 bars	0
147234	LAVEUR 815C GRIS K21P KE10 *	2SCG 8	FEM 21X150	KE 10	15 M	1	400 bars	0
147229	LAVEUR 815C GRIS 2xK22P *	2SCG 8	FEM 22X150	FEM 22X150	15 M	2	400 bars	0
147230	LAVEUR 815C GRIS K22P 22P-TOURN *	2SCG 8	FEM 22X150	ROTATIF 22X150	15 M	2	400 bars	0
147233	LAVEUR 815C GRIS K22P KE10 *	2SCG 8	FEM 22X150	KE 10	15 M	1	400 bars	0
147235	LAVEUR 815C GRIS K22P KE11RLT *	2SCG 8	FEM 22X150	KE11 INOX ROTAT	15 M	1	400 bars	0
LONGUEUR 20M								
147237	LAVEUR 820C GRIS 2xK21 SS POIGNEE *	2SCG 8	FEM 21X150	FEM 21X150	20 M	0	400 bars	0
147239	LAVEUR 820C GRIS 2xK21P *	2SCG 8	FEM 21X150	FEM 21X150	20 M	2	400 bars	0
147241	LAVEUR 820C GRIS K21P K21P-TOURN *	2SCG 8	FEM 21X150	ROTATIF 21X150	20 M	2	400 bars	0
147243	LAVEUR 820C GRIS K21P KE10 *	2SCG 8	FEM 21X150	KE 10	20 M	1	400 bars	0
147236	LAVEUR 820C GRIS 2xK22 SS POIGNEE *	2SCG 8	FEM 22X150	FEM 22X150	20 M	0	400 bars	0
147238	LAVEUR 820C GRIS 2xK22P *	2SCG 8	FEM 22X150	FEM 22X150	20 M	2	400 bars	0
147240	LAVEUR 820C GRIS K22P K22P-TOURN *	2SCG 8	FEM 22X150	ROTATIF 22X150	20 M	2	400 bars	0
147242	LAVEUR 820C GRIS K22P KE10 *	2SCG 8	FEM 22X150	KE 10	20 M	1	400 bars	0
147244	LAVEUR 820C GRIS K22P KE11RLT *	2SCG 8	FEM 22X150	KE11 INOX ROTAT	20 M	1	400 bars	0

2- ADAPTEUR LAVAGE HAUTE PRESSION

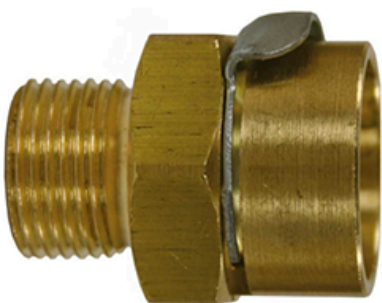
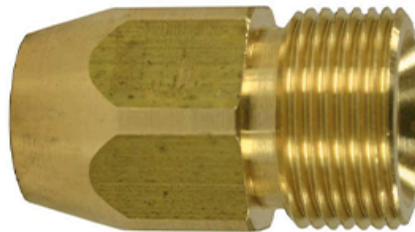
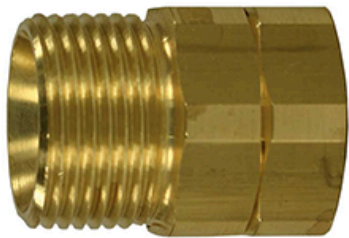

Adapteurs laiton male 22X150 X male 22X150



Adapteurs laiton male 22X150 X male 22X150

Matière : laiton

Code	Référence	D1	D2	Poids
LAV56920	LAV ADAP LAITON M22XM22	M22X150	M22X150	0.05
LAV56940	LAV ADAP LAITON M22XM22 CC	M22X150	M22X150	0.15
LAV56970	LAV ADAP LAITON M22XM22 CC LONG	M22X150	M22X150	0.17

Adapteur laiton male 22 x male 21

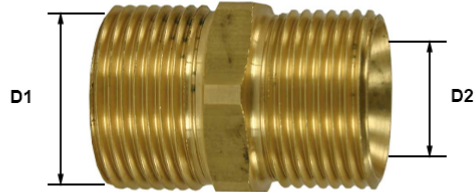

Adapteur laiton male 22 x male 21

Matière : laiton

Code	Référence	D1	D2	Poids
LAV56915	LAV ADAP LAITON M22XM21	M22X150	M21X150	0.05

Adapteur laiton male 21 x male 21

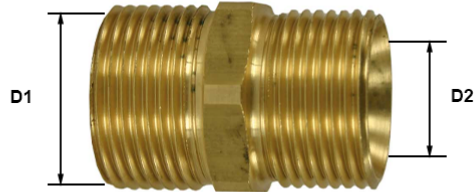

Adapteur laiton male 21 x male 21

Matière : laiton

Code	Référence	D1	D2	Poids
LAV56910	LAV ADAP LAITON M21XM21	M21X150	M21X150	0.05

Adapteur laiton male 22 x male/femelle

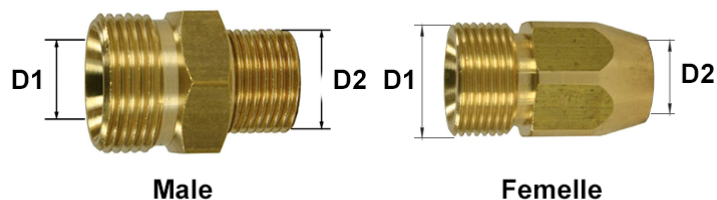

Adapteur laiton male 22 x male/femelle

Matière : laiton

Code	Référence	D1	D2	Poids
FEMELLE COURT				
LAV56580	LAV ADAP LAITON M22XFG1/4	M22X150	FEM 1/4	0.08
LAV56540	LAV ADAP LAITON M22XFG3/8	M22X150	FEM 3/8	0.04
LAV56565	LAV ADAP LAITON M22XFG1/2	M22X150	FEM 1/2	0.05
FEMELLE LONG				
LAV565251	LAV ADAP LAITON M22XFG1/4 LONG	M22X150	FEM 1/4	0.08
LAV565401	LAV ADAP LAITON M22XFG3/8 LONG	M22X150	FEM 3/8	0.08
MALE BSP				
LAV565301	LAV ADAP LAITON M22XMBSP1/4	M22X150	MALE 1/4 BSP	0.05
LAV565501	LAV ADAP LAITON M22XMBSP3/8	M22X150	MALE 3/8 BSP	0.05
MALE GAZ				
LAV56530	LAV ADAP LAITON M22XMG1/4	M22X150	MALE 1/4 GAZ	0.04
LAV56550	LAV ADAP LAITON M22XMG3/8	M22X150	MALE 3/8 GAZ	0.05
LAV56560	LAV ADAP LAITON M22XMG1/2	M22X150	MALE 1/2 GAZ	0.05

Adapteur laiton male 21X150 X femelle/male

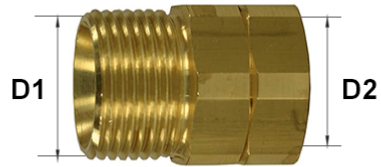

Adapteur laiton male 21X150 X femelle/male

Matière : laiton

Code	Référence	D1	D2	Poids
FEMELLE				
LAV56710	LAV ADAP LAITON M21XFG1/8	M21X150	FEM 1/8	0
LAV56720	LAV ADAP LAITON M21XFG1/4	M21X150	FEM 1/4	0.06
LAV56740	LAV ADAP LAITON M21XFG3/8	M21X150	FEM 3/8	0.07
MALE				
LAV56730	LAV ADAP LAITON M21XMG1/4	M21X150	MALE 1/4 GAZ	0.04
LAV56750	LAV ADAP LAITON M21XMG3/8	M21X150	MALE 3/8 GAZ	0.05

Adapteur laiton male K2000 x femelle

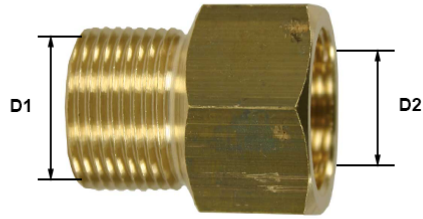

Adapteur laiton male K x femelle

Matière : laiton

Code	Référence	D1	D2	Poids
LAV56566	LAV ADAP LAITON K2000 M22XF22	MALE 22X150	FIXE F22X150	0.07

Adapteurs laiton femelle 22X150 X femelle 22X150

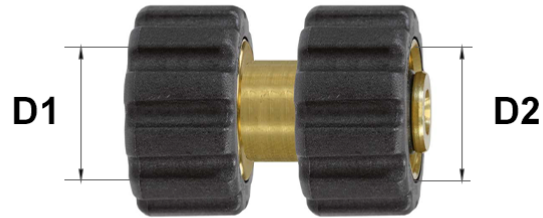

Adapteurs laiton femelle 22X150 X femelle 22X150

Matière : laiton

Code	Référence	D1	D2	Poids
LAV56196	LAV ADAP LAITON F22XF22	F22X150	F22X150	0.13

Adapteur laiton femelle 22 x femelle 21

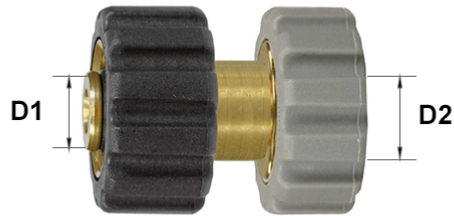

Adapteur laiton femelle 22 x femelle 21

Matière : laiton

Code	Référence	D1	D2	Poids
LAV56197	LAV ADAP LAITON F22XF21	F22X150	F21X150	0

Adapteur laiton femelle 21 x femelle 21

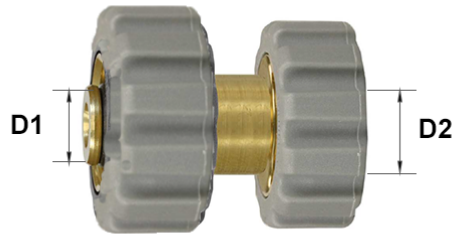

Adapteur laiton femelle 21 x femelle 21

Matière : laiton

Code	Référence	D1	D2	Poids
LAV56465	LAV ADAP LAITON F21XF21	F21X150	F21X150	0

Adapteurs laiton femelle tournant 22X150 X femelle

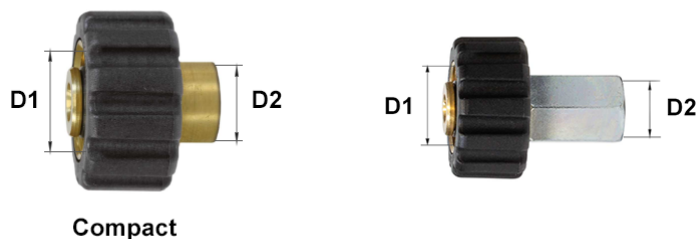

Adapteurs laiton femelle tournant 22X150 X femelle

Code	Référence	D1	D2	Poids
FEMELLE COMPACT				
LAV56010	LAV ADAP LAITON F22XFG1/8 COMPACT	F22X150	FEM 1/8	0.08
LAV56020	LAV ADAP LAITON F22XFG1/4 COMPACT	F22X150	FEM 1/4	0.06
FEMELLE LONG				
LAV56120	LAV ADAP LAITON F22XFG1/8	F22X150	FEM 1/8	0.1
LAV56130	LAV ADAP LAITON F22XFG1/4	F22X150	FEM 1/4	0.12
LAV56150	LAV ADAP LAITON F22XFG3/8	F22X150	FEM 3/8	0.12
LAV56165	LAV ADAP LAITON F22XFG1/2	F22X150	FEM 1/2	0.12

Adapteur laiton femelle 21 x femelle

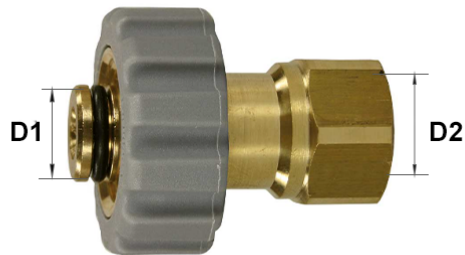

Adapteur laiton femelle 21 x femelle

Matière : laiton

Code	Référence	D1	D2	Poids
FEMELLE				
LAV56400	LAV ADAP LAITON F21XFG1/8	F21X150	FEM 1/8	0.09
LAV56410	LAV ADAP LAITON F21XFG1/4	F21X150	FEM 1/4	0.08
LAV56430	LAV ADAP LAITON F21XF3/8	F21X150	FEM 3/8	0.1

Adapteurs laiton femelle tournant 22X150 X male



Adapteurs laiton femelle tournant 22X150 X male

Matière : laiton

Code	Référence	D1	D2	Poids
MALE COMPACT				
LAV56030	LAV ADAP LAITON F22XMG1/4 COMPACT	F22X150	MALE 1/4 GAZ	0.06
MALE				
LAV56140	LAV ADAP LAITON F22XMG1/4	F22X150	MALE 1/4 GAZ	0.11
LAV56160	LAV ADAP LAITON F22XMG3/8	F22X150	MALE 3/8 GAZ	0.12
LAV56166	LAV ADAP LAITON F22XMG1/2	F22X150	MALE 1/2 GAZ	0.11

Adapteur laiton femelle 21 x femelle 21

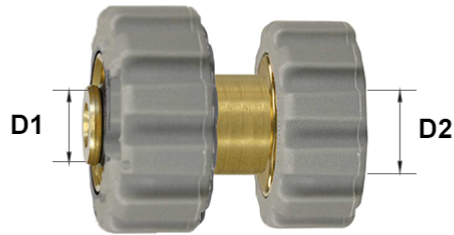

Adapteur laiton femelle 21 x femelle 21

Matière : laiton

Code	Référence	D1	D2	Poids
LAV56465	LAV ADAP LAITON F21XF21	F21X150	F21X150	0

Adapteurs laiton femelle tournant 22X150 X femelle

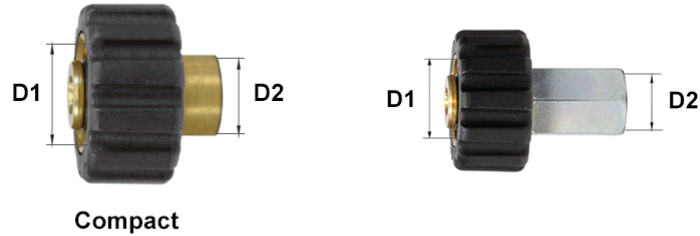

Adapteurs laiton femelle tournant 22X150 X femelle

Matière : laiton

Code	Référence	D1	D2	Poids
FEMELLE COMPACT				
LAV56010	LAV ADAP LAITON F22XFG1/8 COMPACT	F22X150	FEM 1/8	0.08
LAV56020	LAV ADAP LAITON F22XFG1/4 COMPACT	F22X150	FEM 1/4	0.06
FEMELLE LONG				
LAV56120	LAV ADAP LAITON F22XFG1/8	F22X150	FEM 1/8	0.1
LAV56130	LAV ADAP LAITON F22XFG1/4	F22X150	FEM 1/4	0.12
LAV56150	LAV ADAP LAITON F22XFG3/8	F22X150	FEM 3/8	0.12
LAV56165	LAV ADAP LAITON F22XFG1/2	F22X150	FEM 1/2	0.12

Adapteur laiton femelle 21 x femelle

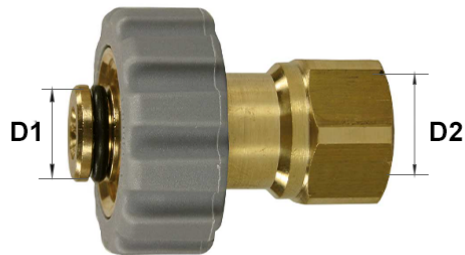

Adapteur laiton femelle 21 x femelle

Matière : laiton

Code	Référence	D1	D2	Poids
FEMELLE				
LAV56400	LAV ADAP LAITON F21XFG1/8	F21X150	FEM 1/8	0.09
LAV56410	LAV ADAP LAITON F21XFG1/4	F21X150	FEM 1/4	0.08
LAV56430	LAV ADAP LAITON F21XF3/8	F21X150	FEM 3/8	0.1

Adapteurs laiton femelle tournant 22X150 X male



Adapteurs laiton femelle tournant 22X150 X male

Matière : laiton

Code	Référence	D1	D2	Poids
MALE COMPACT				
LAV56030	LAV ADAP LAITON F22XMG1/4 COMPACT	F22X150	MALE 1/4 GAZ	0.06
MALE				
LAV56140	LAV ADAP LAITON F22XMG1/4	F22X150	MALE 1/4 GAZ	0.11
LAV56160	LAV ADAP LAITON F22XMG3/8	F22X150	MALE 3/8 GAZ	0.12
LAV56166	LAV ADAP LAITON F22XMG1/2	F22X150	MALE 1/2 GAZ	0.11

Adapteur laiton femelle rotatif 22X150

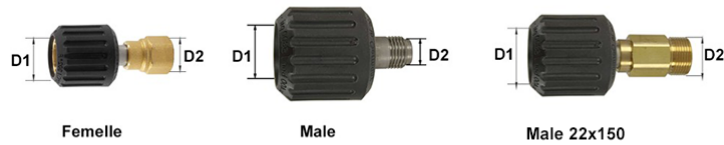

Adapteur laiton femelle rotatif 22X150

Matière : laiton

Code	Référence	D1	D2	Poids
FEMELLE				
LAV56820	LAV ADAP LAITON F22ROT XFG3/8	F22X150 ROTATIF	FEM 3/8	0.19
LAV56821	LAV ADAP LAITON F22ROT XFG1/2	F22X150 ROTATIF	FEM 1/2	0
MALE				
LAV56800	LAV ADAP LAITON F22ROT XMG1/4	F22X150 ROTATIF	MALE 1/4	0.15
LAV56825	LAV ADAP LAITON F22ROT XMG3/8	F22X150 ROTATIF	MALE 3/8	0.18
LAV56826	LAV ADAP LAITON F22ROT XMG1/2	F22X150 ROTATIF	MALE 1/2	0.2
MALE 22X150				
LAV56810	LAV ADAP LAITON F22ROT XM22	F22X150 ROTATIF	MALE 22X150	0.23

Adapteur laiton femelle rotatif 21X150

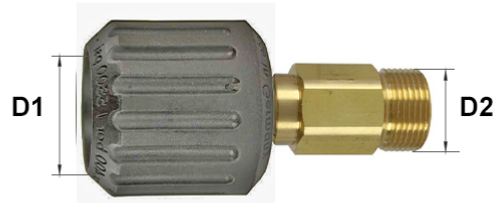

Adapteur laiton femelle rotatif 21X150

Matière : laiton

Code	Référence	D1	D2	Poids
LAV56860	LAV ADAP LAITON F21ROTXM21	F21X150 ROTATIF	MALE 21X150	0
LAV56850	LAV ADAP LAITON F21ROTXMG1/4	F21X150 ROTATIF	MALE 1/4	0.15

Adapteur laiton femelle kw male x femelle gaz



Adapteur laiton femelle kw male x femelle gaz

Matière : laiton

Code	Référence	D1	D2	Poids
LAV55920	LAV ADAP LAITON FG1/4XCOUPLEUR KW	FEM 1/4	KW MALE	0.04

Adapteur laiton gaz x KE femelle

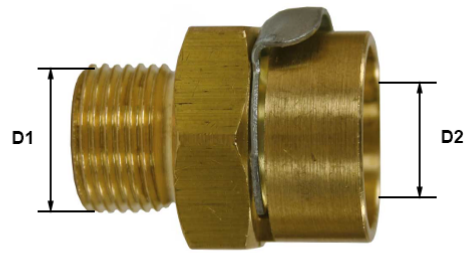

Adapteur laiton gaz x KE femelle

Matière : laiton

Code	Référence	D1	D2	Poids
LAV5599101	LAV ADAP LAITON MG3/8XKE10 FEMELLE	MALE 3/8	KE10 FEMELLE	0.05

Adapteurs spéciaux



COULEUR K



K11 FEMELLE



K10 MALE

Adapteurs spéciaux

Matière : laiton

Code	Référence	D1	D2	Poids
LAV200000435	LAV ADAP LAITON FG1/4XCOUPLEUR K	FEM 1/4	K MALE	0.1
LAV55991138	LAV ADAP LAITON MG3/8XKE11 FEMELLE	MALE 3/8	KE11 FEMELLE	0.02
LAV5599102	LAV ADAP LAITON M22XKE10 MALE	MALE 22X150	KE10 MALE	0

Joint pour raccord femelle 22X150



Joint pour raccord femelle 22X150

D1 : Longueur intérieur
D2 : épaisseur

Code	Référence	D1	D2	Poids
JOINT TORIQUE				
LAV79055	LAV JOINT TORIQUE POUR KE10	6.75mm	1.78mm	0
LAV79057	LAV JOINT TORIQUE POUR KE11	7.75mm	1.78mm	0
LAV568011	LAV JOINT TORIQUE PETIT F22 ROTATIF	17mm	1.25mm	0
LAV568010	LAV JOINT TORIQUE GRAND F22 ROTATIF	17.5mm	1.5mm	0
BAE				
LAV79058	LAV BAGUE ANTI-EXTRUSION POUR KE10	6.73mm	1.35mm	0
LAV79059	LAV BAGUE ANTI-EXTRUSION POUR KE11	7.73mm	1.35mm	0
LAV568008	LAV BAGUE ANTI-EXTRUSION POUR F22	17mm	1.4mm	0.01

Adapteurs laiton divers male X male et femelle x femelle

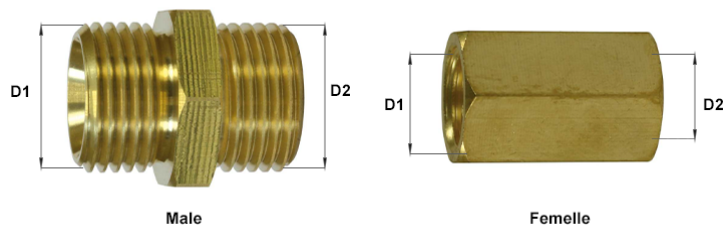

Adapteurs laiton divers male X male et femelle x femelle

Matière : laiton

Code	Référence	D1	D2	Poids
FEMELLE				
LAV51810	LAV ADAP LAITON FG1/8XFG1/8	FEM 1/8	FEM 1/8	0.02
LAV51820	LAV ADAP LAITON FG1/4XFG1/8	FEM 1/4	FEM 1/8	0.03
LAV51830	LAV ADAP LAITON FG1/4XFG1/4	FEM 1/4	FEM 1/4	0.02
LAV51840	LAV ADAP LAITON FG3/8XFG3/8	FEM 3/8	FEM 3/8	0.05
LAV51860	LAV ADAP LAITON FG3/8XFG1/4	FEM 3/8	FEM 1/4	0.04
LAV518504	LAV ADAP LAITON FG1/2XFG1/2	FEM 1/2	FEM 1/2	0.07
LAV518524	LAV ADAP LAITON FG1/2XFG1/4	FEM 1/2	FEM 1/4	0.04
MALE				
LAV57010	LAV ADAP LAITON MG1/8XMG1/8	MALE 1/8	MALE 1/8	0.02
LAV57020	LAV ADAP LAITON MG1/4XMG1/8	MALE 1/4	MALE 1/8	0.02
LAV57040	LAV ADAP LAITON MG1/4XMG1/4	MALE 1/4	MALE 1/4	0.02
LAV57050	LAV ADAP LAITON MG3/8XMG1/4	MALE 3/8	MALE 1/4	0.03
LAV57070	LAV ADAP LAITON MG3/8XMG3/8	MALE 3/8	MALE 3/8	0.03
LAV57060	LAV ADAP LAITON MG1/2XMG1/4	MALE 1/2	MALE 1/4	0.05
LAV57080	LAV ADAP LAITON MG1/2XMG3/8	MALE 1/2	MALE 3/8	0.06
LAV57090	LAV ADAP LAITON MG1/2XMG1/2	MALE 1/2	MALE 1/2	0.06

Adapteurs laiton divers male X femelle

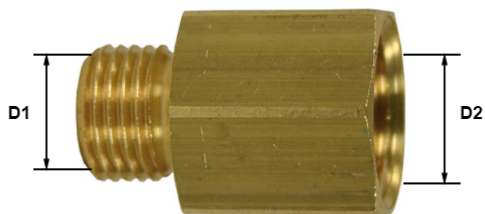

Adapteurs laiton divers male X femelle

Matière : laiton

Code	Référence	D1	D2	Poids
LAV57610	LAV ADAP LAITON MG1/4XFG1/8	MALE 1/4	FEM 1/8	0.03
LAV57620	LAV ADAP LAITON MG1/4XFG1/4	MALE 1/4	FEM 1/4	0.04
LAV57640	LAV ADAP LAITON MG1/4XFG3/8	MALE 1/4	FEM 3/8	0.03
LAV57630	LAV ADAP LAITON MG3/8XFG1/4	MALE 3/8	FEM 1/4	0.03
LAV57650	LAV ADAP LAITON MG3/8XFG3/8	MALE 3/8	FEM 3/8	0.03
LAV57660	LAV ADAP LAITON MG3/8XFG1/2	MALE 3/8	FEM 1/2	0.06
LAV57665	LAV ADAP LAITON MG1/2XFG3/8	MALE 1/2	FEM 3/8	0.08
LAV57680	LAV ADAP LAITON MG1/2XFG1/2	MALE 1/2	FEM 1/2	0.07

3- PISTOLET DE LAVAGE



Pistolet professionnel ST2300



Pistolet professionnel ST2300

Matière : corps de vanne : inox / clapet : inox/acier cémenté

Pression max : 310 bars

Débit : 45l/min

Température : 150°C maximum

HG : Hors gel

Disponible en version HG avec clapet et HG pleureur (pour station de lavage)

Code	Référence	D1	D2	Poids
STANDARD				
LAV202300500	LAV PISTOLET ST2300 F3/8/F1/4	FEM 3/8	FEM 1/4	0
LAV202300550	LAV PISTOLET ST2300 F3/8ROT/F1/4	FEM 3/8 ROT	FEM 1/4	0
LAV202300520	LAV PISTOLET ST2300 M22/F1/4	MALE 22X150	FEM 1/4	0
LAV202300553	LAV PISTOLET ST2300 M22ROT/F1/4	MALE 22X150 ROT	FEM 1/4	0
LAV202300710	LAV PISTOLET ST2300 M22/M22	MALE 22X150	MALE 22X150	0
LAV202300720	LAV PISTOLET ST2300 M22ROT/M22	MALE 22X150 ROT	MALE 22X150	0
LAV202300760	LAV PISTOLET ST2300 M22/F22	MALE 22X150	FEM 22X150	0
HG AVEC CLAPET				
LAV202300582	LAV PISTOLET ST2300 F3/8ROT/F1/4 HG	FEM 3/8 ROTATIF	FEM 1/4	0
HG PLEUREUR				
LAV202300580	LAV PISTOLET ST2300 F3/8/F1/4 HGP	FEM 3/8	FEM 1/4	0
LAV202300581	LAV PISTOLET ST2300 F3/8ROT/F1/4 HGP	FEM 3/8	FEM 1/4	0

Pistolet professionnel ST2600



Pistolet professionnel ST2600

Matière : corps de vanne : laiton / clapet : laiton/inox

Pression max : 310 bars

Débit : 45l/min

Température : 150°C maximum

Système : gâchette à assistance breveté LTF

Information complémentaire : Low trigger force réduite de 90% au maintien et de 40% à l'appui de la gâchette

Code	Référence	D1	D2	Poids
STANDARD				
LAV202600550	LAV PISTOLET ST2600 F3/8ROT/F1/4	FEM 3/8 ROTATIF	FEM 1/4	0.67
LAV202600500	LAV PISTOLET ST2600 F3/8/F1/4	FEM 3/8	FEM 1/4	0
LAV202600553	LAV PISTOLET ST2600 M22ROT/F1/4	M22X150 ROT	FEM 1/4	0.65
LAV202600520	LAV PISTOLET ST2600 M22/F1/4	MALE 22X150	FEM 1/4 .	0
LAV202600730	LAV PISTOLET ST2600 M21/M21	MALE 21X150	MALE 21X150 .	0
LAV202600710	LAV PISTOLET ST2600 M22/M22	MALE 22X150	MALE 22X150	0
LAV202600760	LAV PISTOLET ST2600 M22/F22	MALE 22X150	FEM 22X150	0
LAV202600720	LAV PISTOLET ST2600 M22ROT/M22	MALE 22X150 ROT	MALE 22X150	0
LAV202600701	LAV PISTOLET ST2600 L370 M22ROT/F22	MALE 22X150 ROT	FEM 22X150	0
HG AVEC CLAPET				
LAV202600536	PISTOLET ST-2600 HORS-GEL RACCORD RO	FEM 3/8 ROT	FEM 1/4	0

Pistolet professionnel ST1100



Pistolet professionnel ST1100

Matière : corps de vanne : inox / clapet : inox

Pression max : 210 bars

Débit : 25l/min

Température : 150°C maximum

HGP : Hors gel pleureur (pour station de lavage)

Code	Référence	D1	D2	Poids
STANDARD				
LAV201100500	LAV PISTOLET ST1100 F3/8/F1/4	FEM 3/8	FEM 1/4	0
LAV201100540	LAV PISTOLET ST1100 F3/8ROT/F1/4	FEM 3/8 ROTATIF	FEM 1/4	0
LAV201100545	LAV PISTOLET ST1100 M22/M22	MALE 22X150	MALE 22X150	0
HG PLEUREUR				
LAV201100530	LAV PISTOLET ST1100 F3/8ROT/F1/4 HGP	FEM 3/8 ROTATIF	FEM 1/4	0
LAV201100535	LAV PISTOLET ST1100 F3/8/F1/4 HGP	FEM 3/8	FEM 1/4	0

Pistolet professionnel pour station de lavage type ST1500



Pistolet professionnel pour station de lavage type ST1500

Pression max : 275 bars
Débit : 45l/min
Température : 150°C maximum
HG/HGP

Code	Référence	D1	D2	Poids
LAV201500580	LAV PISTOLET ST1500 F3/8/F1/4 HG	FEM 3/8	FEM 1/4	0
LAV201500581	LAV PISTOLET ST1500 F3/8/ROT/F1/4 HG	FEM 3/8	FEM 1/4	0
LAV201500620	LAV PISTOLET ST1500 F3/8/F1/4 HGP	FEM 3/8	FEM 1/4	0
LAV201500750	LAV PISTOLET ST1500 F3/8/F1/4 PL	FEM 3/8	FEM 1/4	0
LAV201500500	LAV PISTOLET ST1500 F3/8/F1/4	FEM 3/8	FEM 1/4	0

Pistolet professionnel ST1500



Pistolet professionnel ST1500

Pression max : 275 bars
Débit : 45l/min
Température : 150°C maximum

Code	Référence	D1	D2	Poids
LAV201500760	LAV PISTOLET ST1500 M22/F22	MALE 22X150	FEM 22X150	0
LAV201500645	LAV PISTOLET ST1500 M21/M21	MALE 21X150	MALE 21X150	0
LAV201500550	LAV PISTOLET ST1500 M22/F1/4	MALE 22X150	FEM 1/4	0
LAV201500560	LAV PISTOLET ST1500 F3/8ROT/F1/4	FEM 3/8 ROTATIF	FEM 1/4	0.658

Pistolet professionnel inox ST2700



Pistolet professionnel inox ST2700

Matière : corps de vanne : inox / clapet : inox
Pression max : 350 bars
Débit : 45l/min
Température : 150°C maximum
Système : gachette à assistance breveté LTF
 Version alimentaire

Code	Référence	D1	D2	Poids
LAV202700500	LAV PISTOLET ST2700 F3/8/F1/4	FEM 3/8	FEM 1/4	0

Pistolet THP ST2750



Pistolet très haute pression ST2750

Matière : corps de vanne : inox / clapet : inox/acier cémenté

Pression max : 500 bars

Débit : 30l/min

Température : 150°C maximum

Système : gachette à assistance breveté LTF

Code	Référence	D1	D2	Poids
LAV202750500	LAV PISTOLET ST2750 F3/8/F1/4	FEM 3/8	FEM 1/4	0

Pistolet THP ST3600



Pistolet très haute pression ST3600

Matière : corps de vanne : inox / clapet : inox

Pression max : 600 bars

Débit : 80l/min

Température : 150°C maximum

Code	Référence	D1	D2	Poids
LAV203600545	LAV PISTOLET ST3600 F1/4/F1/2	FEM 1/4	FEM 1/2	0
LAV203600550	LAV PISTOLET ST3600 F1/2/F1/2	FEM 1/2	FEM 1/2	0
LAV203600570	LAV PISTOLET ST3600 F1/2/F1/2ROT	FEM 1/2	FEM 1/2 ROT	0

Pistolet de lavage - jet à réglage



Pistolet de lavage - jet à réglage

Matière : laiton ou inox au choix

Pression max : 24 bars

Débit : 100l/min

Température : 50°C maximum

Code	Référence	D1	D2	Poids
LAV201200500	LAV PISTOLET BP LAITON F1/2	FEM 1/2		0
LAV201200520	LAV PISTOLET BP INOX F1/2 24BARS	FEM 1/2		0

4- LANCE DE LAVAGE



Tube lance acier ou inox surmoule avec protège base

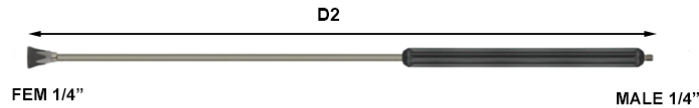

Tube lance acier ou inox surmoule avec protège buse fem 1/4

(avec protège buse référence : 51905 // livré sans buse)
(Information : également livrable en version coudée)

Pression max : 400 bars
Température : 150°C maximum

Code	Référence	D1	D2	Poids
ACIER				
LAV512103	LAV LANCE SM+PB 1/4 L500	MALE 1/4	500mm	0
LAV512203	LAV LANCE SM+PB 1/4 L600	MALE 1/4	600mm	0
LAV512303	LAV LANCE SM+PB 1/4 L800	MALE 1/4	800mm	0.64
LAV512403	LAV LANCE SM+PB 1/4 L1000	MALE 1/4	1000mm	0.73
LAV512503	LAV LANCE SM+PB 1/4 L1200	MALE 1/4	1200mm	0.89
LAV512603	LAV LANCE SM+PB 1/4 L1500	MALE 1/4	1500mm	1.02
LAV512803	LAV LANCE SM+PB 1/4 L2000	MALE 1/4	2000mm	0
INOX				
LAV512193	LAV LANCE SM+PB 1/4 L500 INOX	MALE 1/4	500mm	0
LAV512293	LAV LANCE SM+PB 1/4 L600 INOX	MALE 1/4	600mm	0
LAV512393	LAV LANCE SM+PB 1/4 L800 INOX	MALE 1/4	800mm	0
LAV512493	LAV LANCE SM+PB 1/4 L1000 INOX	MALE 1/4	1000mm	0.67
LAV512593	LAV LANCE SM+PB 1/4 L1200 INOX	MALE 1/4	1200mm	0.78
LAV512693	LAV LANCE SM+PB 1/4 L1500 INOX	MALE 1/4	1500mm	0
LAV512893	LAV LANCE SM+PB 1/4 L2000 INOX	MALE 1/4	2000mm	1.15

Tube lance acier ou inox surmoule

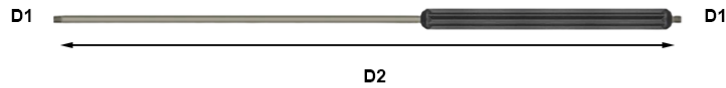

Tube lance acier ou inox surmoule

Pression max : 400 bars
Température : 150°C maximum

Code	Référence	D1	D2	Poids
ACIER				
LAV070000170	LAV LANCE SM 1/4 L500	MALE 1/4	500mm	0.47
LAV070000180	LAV LANCE SM 1/4 L600	MALE 1/4	600mm	0.45
LAV070000190	LAV LANCE SM 1/4 L800	MALE 1/4	800mm	0.6
LAV070000470	LAV LANCE SM 1/4 L900	MALE 1/4	900mm	0
LAV070000200	LAV LANCE SM 1/4 L1000	MALE 1/4	1000mm	0.68
LAV070000210	LAV LANCE SM 1/4 L1200	MALE 1/4	1200mm	0.84
LAV070000220	LAV LANCE SM 1/4 L1500	MALE 1/4	1500mm	0.98
LAV070000230	LAV LANCE SM 1/4 L2000	MALE 1/4	2000mm	1.3
INOX				
LAV070009433	LAV LANCE SM 1/4 L433 INOX	MALE 1/4	433mm	0
LAV070005009	LAV LANCE SM 1/4 L500 INOX	MALE 1/4	500mm	0.36
LAV070006009	LAV LANCE SM 1/4 L600 INOX	MALE 1/4	600mm	0
LAV070007009	LAV LANCE SM 1/4 L700 INOX	MALE 1/4	700mm	0
LAV070008009	LAV LANCE SM 1/4 L800 INOX	MALE 1/4	800mm	0.53
LAV070010009	LAV LANCE SM 1/4 L1000 INOX	MALE 1/4	1000mm	0.62
LAV070012009	LAV LANCE SM 1/4 L1200 INOX	MALE 1/4	1200mm	0.73
LAV070015009	LAV LANCE SM 1/4 L1500 INOX	MALE 1/4	1500mm	0.88
LAV070020009	LAV LANCE SM 1/4 L2000 INOX	MALE 1/4	2000mm	0

Tube lance acier ou inox nu

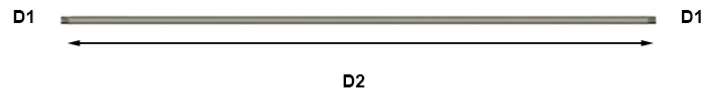

Tube lance acier ou inox nu

Pression max : 400 bars
Température : 150°C maximum

Code	Référence	D1	D2	Poids
ACIER				
LAV07000076	LAV LANCE NU 1/4 L400	MALE 1/4	400mm	0
LAV07000026	LAV LANCE NU 1/4 L431	MALE 1/4	431mm	0.2
LAV07000030	LAV LANCE NU 1/4 L500	MALE 1/4	500mm	0.25
LAV07000040	LAV LANCE NU 1/4 L600	MALE 1/4	600mm	0.29
LAV07000050	LAV LANCE NU 1/4 L800	MALE 1/4	800mm	0.38
LAV07000060	LAV LANCE NU 1/4 L1000	MALE 1/4	1000mm	0.5
LAV07000070	LAV LANCE NU 1/4 L1200	MALE 1/4	1200mm	0.57
LAV07000080	LAV LANCE NU 1/4 L1500	MALE 1/4	1500mm	0.74
LAV07000090	LAV LANCE NU 1/4 L2000	MALE 1/4	2000mm	1
INOX				
LAV07000408	LAV LANCE NU 1/4 L400 INOX	MALE 1/4	400mm	0
LAV07000438	LAV LANCE NU 1/4 L433 INOX	MALE 1/4	433mm	0.18
LAV07000508	LAV LANCE NU 1/4 L500 INOX	MALE 1/4"	500mm	0
LAV07000608	LAV LANCE NU 1/4 L600 INOX	MALE 1/4"	600mm	0
LAV07000808	LAV LANCE NU 1/4 L800 INOX	MALE 1/4	800mm	0
LAV07001008	LAV LANCE NU 1/4 L1000 INOX	MALE 1/4	1000mm	0
LAV07001208	LAV LANCE NU 1/4 L1200 INOX	MALE 1/4	1200mm	0
LAV07001508	LAV LANCE NU 1/4 L1500 INOX	MALE 1/4	1500mm	0
LAV07002008	LAV LANCE NU 1/4 L2000 INOX	MALE 1/4	2000mm	0

Double lance avec protégé-buse et buse basse pression

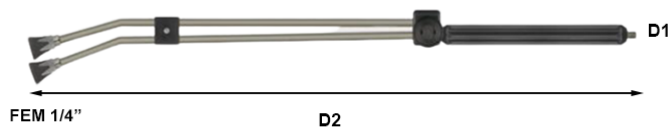

Double lance avec protégé-buse et buse basse pression (avec robinet latéral)

Pression max : 310 bars
Débit : 45l/min
Température : 150°C maximum

Code	Référence	D1	D2	Poids
ACIER				
LAV200054580	LAV DOUBLE LANCE F1/4 L385 ACIER	FEM 1/4	385mm	0
LAV516055	LAV DOUBLE LANCE CPL KW L410 ACIER	CPL KW	410mm	0
LAV200053535	LAV DOUBLE LANCE M1/4 L650 ACIER	MALE 1/4	650mm	0
LAV51750	LAV DOUBLE LANCE F1/4 L650 ACIER	FEM 1/4	650mm	0.94
LAV517501	LAV DOUBLE LANCE M22M L650 ACIER	M22X150	650mm	0
LAV51660	LAV DOUBLE LANCE 1/4F L980 ACIER	FEM 1/4	980mm	0
LAV516605	LAV DOUBLE LANCE CPL KW L980 ACIER	CPL KW	980mm	0
LAV51760	LAV LANCE DOUBLE F1/4 L980 ACIER	FEM 1/4	980mm	0
LAV517601	LAV LANCE DOUBLE M22F L980 ACIER ROB	F22X150	980mm	0
LAV5176085	LAV DOUBLE LANCE M22F ROT L980 ACIER	F22X150 ROT	980mm	0
LAV516105	LAV DOUBLE LANCE CPL KW L1000 ACIER	CPL KW	1000mm	0
LAV51710	LAV LANCE DOUBLE F1/4 L1000 ACIER	FEM 1/4	1000mm	0
LAV51720	LAV DOUBLE LANCE 1/4F L1500 ACIER	FEM 1/4	1500mm	0
INOX				
LAV200053610	LAV DOUBLE LANCE F1/4 L650 INOX	FEM 1/4	650mm	0
LAV200054605	LAV DOUBLE LANCE F1/4 L650 INOX	FEM 1/4	650mm	0
LAV5175019	LAV DOUBLE LANCE M22M L650 INOX	M22X150	650mm	0
LAV5176019	LAV DOUBLE LANCE M22F L980 INOX ROB	F22X150	980mm	0
LAV200054630	LAV DOUBLE LANCE CPL KW L980 INOX	CPL KW	980mm	0
LAV5161059	LAV DOUBLE LANCE CPL KW L1000 INOX	CPL KW	1000mm	0
LAV200054600	LAV DOUBLE LANCE F1/4 L980 INOX	FEM 1/4	1000mm	1.14
LAV517109	LAV DOUBLE LANCE 1/4F L1000 INOX	FEM 1/4	1000mm	0
LAV5161559	LAV DOUBLE LANCE CPL KW L1500 INOX	CPL KW	1500mm	0
LAV517209	LAV DOUBLE LANCE 1/4F L1500 INOX	FEM 1/4	1500mm	0
LAV517309	LAV DOUBLE LANCE 1/4F L2000 INOX	FEM 1/4	2000mm	0

Lance push-pull

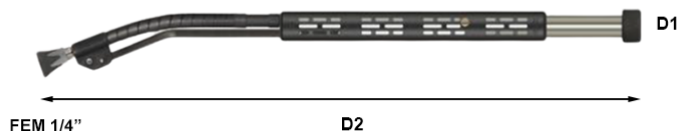

Lance push-pull

Pression max : 210 bars
Débit : 45l/min
Température : 150°C maximum

Code	Référence	D1	D2	Poids
ACIER				
LAV200085210	LAV LANCE PUSH-PULL KW L600 ACIER	CPL KW	600mm	0
LAV200085220	LAV LANCE PUSH-PULL M22 L600 ACIER	MALE 22X150	600mm	0
LAV200085510	LAV LANCE PUSH-PULL KW L850 ACIER	CPL KW	850mm	0
LAV200085640	LAV LANCE PUSH-PULL M22F ROT L850	CPL KW	850mm	0
LAV200085645	LAV LANCE PUSH-PULL M22F ROT L850	F22X150	850mm	0
LAV200085646	PUSH & PULL 850 MM "K" BIG VARIO I	F22X150 ROT	850mm	0
LAV200085713	LAV LANCE PUSH-PULL M22F ROT L850	F22X150 ROT	850mm	0
LAV200085720	LAV LANCE PUSH-PULL M22F L850 ACIER	F22X150	850mm	0
LAV200085740	LAV LANCE PUSH-PULL M22F ROT L850	F22X150 ROT	850mm	0
LAV200085745	LAV LANCE PUSH-PULL M22F ROT L850	F22X150 ROT	850mm	0
LAV200085746	PUSH & PULL 850 MM "K" VARIO	F22X150 ROT	850mm	0
LAV200085710	LAV LANCE PUSH-PULL F1/4 L850	FEM 1/4	850mm	1.07
LAV200085500	LAV LANCE PUSH-PULL KW L1000 ACIER	CPL KW	1000mm	0
LAV200085703	LAV LANCE PUSH-PULL M22F ROT L1000	F22X150 ROT	1000mm	0
LAV200085920	LAV LANCE PUSH-PULL M22F ROT L1000	F22X150 ROT	1000mm	0
LAV200085925	LAV LANCE PUSH-PULL M22F ROT L1000	F22X150 ROT	1000mm	0
LAV200085926	LANCE "PUSH & PULL" 1000 MM "K" VARI	F22X150 ROT	1000mm	0
LAV200085930	LAV LANCE PUSH-PULL M22F ROT L1000	F22X150 ROT	1000mm	0
LAV200085935	LAV LANCE PUSH-PULL M22F ROT L1000	F22X150 ROT	1000mm	0
LAV200085700	LAV LANCE PUSH-PULL F1/4 L1000	FEM 1/4	1000mm	1.24
LAV200085550	LAV LANCE PUSH-PULL KW L1500 ACIER	CPL KW	1500mm	0
LAV200085680	LAV LANCE PUSH-PULL M22F ROT L1500	F22X150 ROT	1500mm	0
LAV200085750	LAV LANCE PUSH-PULL F1/4 L1500	FEM 1/4	1500mm	0
LAV200085685	LAV LANCE PUSH-PULL M22F ROT L1500	F22X150 ROT	1500mm	0
LAV200085760	LAV LANCE PUSH-PULL M22F L1500 ACIER	F22X150	1500mm	0
LAV200085780	LAV LANCE PUSH-PULL M22F ROT L1500	F22X150 ROT	1500mm	0
LAV200085785	LAV LANCE PUSH-PULL M22F ROT L1500	F22X150 ROT	1500mm	0
LAV200085786	PUSH & PULL 1500 MM "K" VARIO	F22X150 ROT	1500mm	0
INOX				
LAV200085260	LAV LANCE PUSH PULL KW L600 INOX	CPL KW	600mm	0
LAV200085270	LAV LANCE PUSH-PULL M22 L600 INOX	M22X150	600mm	0
LAV200085610	LANCE LANCE PUSH-PULL KW L850 INOX	CPL KW	850mm	0
LAV200085620	LAV LANCE PUSH-PULL M22F L850 INOX	F22X150	850mm	0
LAV200085810	LAV LANCE PUSH-PULL F1/4 L850 INOX	FEM 1/4	850mm	0
LAV200085600	LAV LANCE PUSH-PULL KW L1000 INOX	CPL KW	1000mm	0
LAV200085800	LAV LANCE PUSH-PULL F1/4 L1000 INOX	FEM 1/4	1000mm	0

Code	Référence	D1	D2	Poids
LAV200085936	PUSH & PULL 1000 MM "K" VARIO INOX	F22X150 ROT	1000mm	0
LAV200085650	LAV LANCE PUSH-PULL KW L1500 INOX	CPL KW	1500mm	0
LAV200085660	LAV LANCE PUSH-PULL M22F L1500 INOX	F22X150	1500mm	0
LAV200085686	PUSH & PULL 1500 MM "K" VARIO INOX	F22X150 ROT	1500mm	0
LAV200085850	LAV LANCE PUSH-PULL F1/4 L1500 INOX	FEM 1/4	1500mm	0

Protège buse pour buse male



Protège buse pour buse male

Code	Référence	D1	D2	Poids
CAOUTCHOUC				
LAV51905	LAV PROTEGE BUSE 1/4 CAOUTCHOUC	FEM 1/4 GAZ	FEM 1/4 NPT	0.06
INOX				
LAV200010700	LAV PROTEGE BUSE 1/4 PVC NOIR INOX	FEM 1/4 GAZ	FEM 1/4 NPT	0
LAV200010710	LAV PROTEGE BUSE 1/4 PVC BLEU/N INOX	FEM 1/4 GAZ	FEM 1/4 NPT	0
LAV200010720	LAV PROTEGE BUSE 1/4 PVC ROUGE INOX	FEM 1/4 GAZ	FEM 1/4 NPT	0
LAV200010730	LAV PROTEGE BUSE 1/4 PVC NOIR/G INOX	FEM 1/4 GAZ	FEM 1/4 NPT	0
PVC				
LAV200010530	LAV PROTEGE BUSE 1/4 PVC GRIS	FEM 1/4 GAZ	FEM 1/4 NPT	0.05
LAV200010520	LAV PROTEGE BUSE 1/4 PVC ROUGE	FEM 1/4 GAZ	FEM 1/4 NPT	0.04
LAV200000003	LAV PROTEGE BUSE 1/4 PVC 2 PIECES	FEM 1/4	FEM 1/4 NPT	0.05

Adaptateur et protégé buse pastille 18X150



Adaptateur



Porte-buse
pastille



Protège
buse



Joint
torique

Adaptateur et protégé buse pastille 18X150

Code	Référence	D1	D2	Poids
JOINT TORIQUE				
LAV79025	LAV JOINT TORIQUE POUR F22	10mm	2.2mm	0
AUTRES				
LAV51960	LAV ECROU PROTEGE BUSE PASTILLE M18F	FEM 18X150		0
LAITON				
LAV01000043	LAV ADAP LAITON F1/4:M18M	FEM 1/4 GAZ	MALE 18X150	0
LAV51940	LAV ADAP LAITON F18:F1/4	FEM 18X150	FEM 1/4 GAZ	0

Lance inox très haute pression 600 bars avec poignée latérale et protège buse

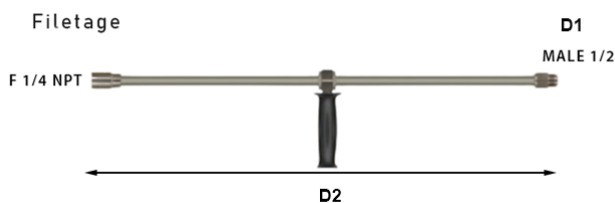

Lance inox très haute pression 600 bars avec poignée latérale et protège buse (sortie buse femelle 1/4)

Pression max : 600 bars
Débit : 80l/min
Température : 150°C maximum

Code	Référence	D1	D2	Poids
LAV203600400	LAV LANCE 600B M1/2XF1/4 L500	MALE 1/2	500mm	0.76
LAV203600401	LAV LANCE 600B M1/2XF1/4 L800	MALE 1/2	800mm	0.74
LAV203600402	LAV LANCE 600B M1/2XF1/4 L1000	MALE 1/2	1000mm	0.74

Lance inox très haute pression 600 bars avec poignée latérale pour rotabuse

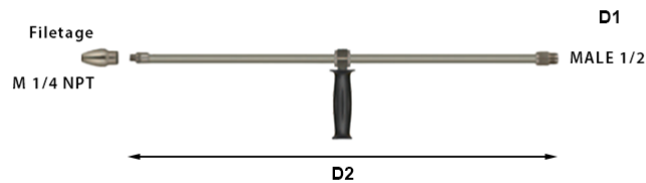

Lance inox très haute pression 600 bars avec poignée latérale pour rotabuse (sortie mâle 1/4)

Pression max : 600 bars
Débit : 80l/min
Température : 150°C maximum

Code	Référence	D1	D2	Poids
ACIER				
LAV203600411	LAV LANCE 600B M1/2XM1/4 L500	MALE 1/2	500mm	0.66
LAV203600410	LAV LANCE 600B M1/2XM1/4 L800	MALE 1/2	800mm	0.66
LAV203600412	LAV LANCE 600B M1/2XM1/4 L1000	MALE 1/2	1000mm	0.66
INOX				
LAV203600444	LANCE INOX ST-3600 L500 ST-45	CPL ST-45 MALE	500mm	0
LAV203600441	LANCE INOX ST-3600 L800 ST-45	CPL ST-45 MALE	800mm	0

5- BUSE ET ROTABUSE HAUTE PRESSION



Buse standard male 1/4 - jet ouvert angle 0°, 15°, 25° et 40°



Buse standard male 1/4 NPT - jet ouvert angle 0°, 15°, 25° et 40°

Matière : inox
Male 1/4"NPT

Code	Référence	D1	D2	Poids
0°				
LAV61005	LAV BUSE M1/4 00-020	0°	D 020	0.02
LAV61007	LAV BUSE M1/4 00-025	0°	D 025	0.02
LAV61010	LAV BUSE M1/4 00-030	0°	D 030	0.02
LAV61020	LAV BUSE M1/4 00-035	0°	D 035	0.02
LAV61030	LAV BUSE M1/4 00-040	0°	D 040	0.02
LAV61040	LAV BUSE M1/4 00-045	0°	D 045	0.02
LAV61050	LAV BUSE M1/4 00-050	0°	D 050	0.02
LAV61060	LAV BUSE M1/4 00-055	0°	D 055	0.02
LAV61070	LAV BUSE M1/4 00-060	0°	D 060	0.02
LAV61080	LAV BUSE M1/4 00-065	0°	D 065	0.02
LAV61090	LAV BUSE M1/4 00-070	0°	D 070	0.02
LAV61100	LAV BUSE M1/4 00-075	0°	D 075	0.02
LAV61110	LAV BUSE M1/4 00-080	0°	D 080	0.02
LAV61120	LAV BUSE M1/4 00-085	0°	D 085	0.02
LAV61130	LAV BUSE M1/4 00-090	0°	D 090	0.02
LAV61140	LAV BUSE M1/4 00-100	0°	D 100	0.02
LAV61150	LAV BUSE M1/4 00-110	0°	D 110	0.02
LAV61160	LAV BUSE M1/4 00-120	0°	D 120	0.02
LAV61170	LAV BUSE M1/4 00-130	0°	D 130	0.02
LAV61175	LAV BUSE M1/4 00-140	0°	D 140	0.02
LAV61180	LAV BUSE M1/4 00-150	0°	D 150	0.02
LAV61190	LAV BUSE M1/4 00-200	0°	D 200	0.02
LAV61200	LAV BUSE M1/4 00-250	0°	D 250	0.02
LAV61210	LAV BUSE M1/4 00-300	0°	D 300	0.02
LAV61215	LAV BUSE M1/4 00-400	0°	D 400	0.02
15°				
LAV61305	LAV BUSE M1/4 15-020	15°	D 020	0
LAV61307	LAV BUSE M1/4 15-025	15°	D 025	0
LAV61320	LAV BUSE M1/4 15-034	15°	D 034	0
LAV61330	LAV BUSE M1/4 15-040	15°	D 040	0
LAV61350	LAV BUSE M1/4 15-050	15°	D 050	0
LAV61370	LAV BUSE M1/4 15-060	15°	D 060	0
LAV61380	LAV BUSE M1/4 15-065	15°	D 065	0
LAV61400	LAV BUSE M1/4 15-075	15°	D 075	0
LAV61410	LAV BUSE M1/4 15-080	15°	D 080	0
LAV61420	LAV BUSE M1/4 15-085	15°	D 085	0
LAV61430	LAV BUSE M1/4 015-090	15°	D 090	0

Code	Référence	D1	D2	Poids
LAV61440	LAV BUSE M1/4 15-100	15°	D 100	0
LAV61450	LAV BUSE M1/4 15-110	15°	D 110	0
LAV61460	LAV BUSE M1/4 15-120	15°	D 120	0
LAV61470	LAV BUSE M1/4 15-130	15°	D 130	0
LAV61475	LAV BUSE M1/4 15-140	15°	D 140	0
LAV61490	LAV BUSE M1/4 15-200	15°	D 200	0
LAV61500	LAV BUSE M1/4 15-250	15°	D 250	0
LAV61510	LAV BUSE M1/4 15-300	15°	D 300	0
LAV61520	LAV BUSE M1/4 15-350	15°	D 350	0
LAV61525	LAV BUSE M1/4 15-400	15°	D 400	0
LAV61535	LAV BUSE M1/4 15-500	15°	D 500	0
25°				
LAV61750	LAV BUSE M1/4 25-020	25°	D 020	0.02
LAV61765	LAV BUSE M1/4 25-025	25°	D 025	0.02
LAV61770	LAV BUSE M1/4 25-030	25°	D 030	0.02
LAV61780	LAV BUSE M1/4 25-035	0°	D 035	0.02
LAV61790	LAV BUSE M1/4 25-040	25°	D 040	0.02
LAV61800	LAV BUSE M1/4 25-045	25°	D 045	0.02
LAV61810	LAV BUSE M1/4 25-050	25°	D 050	0.02
LAV61820	LAV BUSE M1/4 25-055	25°	D 055	0.02
LAV61830	LAV BUSE M1/4 25-060	25°	D 060	0.02
LAV61840	LAV BUSE M1/4 25-065	25°	D 065	0.02
LAV61850	LAV BUSE M1/4 25-070	25°	D 070	0.02
LAV61860	LAV BUSE M1/4 25-075	25°	D 075	0.02
LAV61870	LAV BUSE M1/4 25-080	25°	D 080	0.02
LAV61880	LAV BUSE M1/4 25-085	25°	D 085	0.02
LAV61900	LAV BUSE M1/4 25-100	25°	D 100	0.02
LAV61910	LAV BUSE M1/4 25-110	25°	D 110	0.02
LAV61920	LAV BUSE M1/4 25-120	25°	D 120	0.02
LAV61930	LAV BUSE M1/4 25-130	25°	D 130	0.02
LAV61935	LAV BUSE M1/4 25-140	25°	D 140	0.02
LAV61940	LAV BUSE M1/4 25-150	25°	D 150	0.02
LAV61950	LAV BUSE M1/4 25-200	25°	D 200	0.02
LAV61960	LAV BUSE M1/4 25-250	25°	D 250	0.02
LAV61970	LAV BUSE M1/4 25-300	25°	D 300	0.02
LAV61980	LAV BUSE M1/4 25-400	25°	D 400	0.02
40°				
LAV62030	LAV BUSE M1/4 40-020	40°	D 020	0.02
LAV62035	LAV BUSE M1/4 40-025	40°	D 025	0.02
LAV62100	LAV BUSE M1/4 40-030	40°	D 030	0.02
LAV62120	LAV BUSE M1/4 40-035	40°	D 035	0.02
LAV62130	LAV BUSE M1/4 40-040	40°	D 040	0.02
LAV62140	LAV BUSE M1/4 40-045	40°	D 045	0.02
LAV62150	LAV BUSE M1/4 40-050	40°	D 050	0.02
LAV62160	LAV BUSE M1/4 40-055	40°	D 055	0.02
LAV62170	LAV BUSE M1/4 40-060	40°	D 060	0.02
LAV62180	LAV BUSE M1/4 40-065	40°	D 065	0.02
LAV62190	LAV BUSE M1/4 40-070	40°	D 070	0.02
LAV62200	LAV BUSE M1/4 40-075	40°	D 075	0.02
LAV62210	LAV BUSE M1/4 40-080	40°	D 080	0.02
LAV62220	LAV BUSE M1/4 40-085	40°	D 085	0.02
LAV62230	LAV BUSE M1/4 40-090	40°	D 090	0.02
LAV62240	LAV BUSE M1/4 40-100	40°	D 100	0.02
LAV62250	LAV BUSE M1/4 40-110	40°	D 110	0.02
LAV62260	LAV BUSE M1/4 40-120	40°	D 120	0.02
LAV62270	LAV BUSE M1/4 40-130	40°	D 130	0.02
LAV62280	LAV BUSE M1/4 40-150	40°	D 150	0.02
LAV62290	LAV BUSE M1/4 40-200	40°	D 200	0.02
LAV62300	LAV BUSE M1/4 40-250	40°	D 250	0.02
LAV62320	LAV BUSE M1/4 40-300	40°	D 300	0.02
LAV62330	LAV BUSE M1/4 40-400	40°	D 400	0.02

Buse standard male 1/8 - jet ouvert angle 0°, 15°, 25° et 40°



Buse standard male 1/8 NPT - jet ouvert angle 0°, 15°, 25° et 40°

Matière : inox
Male 1/8 NPT

Code	Référence	D1	D2	Poids
0°				
LAV63008	LAV BUSE M1/8 00-020	0°	D 020	0.01
LAV63010	LAV BUSE M1/8 00-030	0°	D 030	0.01
LAV63020	LAV BUSE M1/8 00-040	0°	D 040	0.01
LAV63030	LAV BUSE M1/8 00-045	0°	D 045	0.01
LAV63040	LAV BUSE M1/8 00-050	0°	D 050	0.01
LAV63050	LAV BUSE M1/8 00-055	0°	D 055	0.01
LAV63060	LAV BUSE M1/8 00-060	0°	D 060	0.01
LAV63070	LAV BUSE M1/8 00-065	0°	D 065	0.01
LAV63080	LAV BUSE M1/8 00-070	0°	D 070	0.01
LAV63090	LAV BUSE M1/8 00-075	0°	D 075	0.01
LAV63100	LAV BUSE M1/8 00-080	0°	D 080	0.01
LAV63110	LAV BUSE M1/8 00-085	0°	D 085	0.01
LAV63120	LAV BUSE M1/8 00-090	0°	D 090	0.01
LAV63130	LAV BUSE M1/8 00-100	0°	D 100	0.01
15°				
LAV63225	LAV BUSE M1/8 15-025	15°	D 025	0
LAV63230	LAV BUSE M1/8 15-045	15°	D 045	0
LAV63240	LAV BUSE M1/8 15-050	15°	D 050	0
LAV63250	LAV BUSE M1/8 15-055	15°	D 055	0
LAV63260	LAV BUSE M1/8 15-060	15°	D 060	0
LAV63270	LAV BUSE M1/8 15-065	15°	D 065	0
LAV63280	LAV BUSE M1/8 15-070	15°	D 070	0
LAV63285	LAV BUSE M1/8 15-075	15°	D 075	0
LAV63300	LAV BUSE M1/8 15-080	15°	D 080	0
LAV63310	LAV BUSE M1/8 15-085	15°	D 085	0
LAV63320	LAV BUSE M1/8 15-090	15°	D 090	0
LAV63330	LAV BUSE M1/8 15-100	15°	D 100	0
LAV63360	LAV BUSE M1/8 15-150	15°	D 150	0
25°				
LAV63500	LAV BUSE M1/8 25-020	25°	D 020	0.01
LAV63510	LAV BUSE M1/8 25-030	25°	D 030	0.01
LAV63515	LAV BUSE M1/8 25-035	25°	D 035	0.02
LAV63520	LAV BUSE M1/8 25-040	25°	D 040	0.01
LAV63530	LAV BUSE M1/8 25-045	25°	D 045	0.01
LAV63540	LAV BUSE M1/8 25-050	25°	D 050	0.01
LAV63550	LAV BUSE M1/8 25-055	25°	D 055	0.01
LAV63560	LAV BUSE M1/8 25-060	25°	D 060	0.01

Code	Référence	D1	D2	Poids
LAV63570	LAV BUSE M1/8 25-065	25°	D 065	0.01
LAV63580	LAV BUSE M1/8 25-070	25°	D 070	0.01
LAV63590	LAV BUSE M1/8 25-075	25°	D 075	0.01
LAV63600	LAV BUSE M1/8 25-080	25°	D 080	0.01
LAV63610	LAV BUSE M1/8 25-085	25°	D 085	0.01
LAV63620	LAV BUSE M1/8 25-090	25°	D 090	0.01
LAV63630	LAV BUSE M1/8 25-100	25°	D 100	0.01
40°				
LAV63810	LAV BUSE M1/8 40-030	40°	D 030	0.01
LAV63820	LAV BUSE M1/8 40-040	40°	D 040	0.01
LAV63830	LAV BUSE M1/8 40-045	40°	D 045	0.01
LAV63840	LAV BUSE M1/8 40-050	40°	D 050	0.01
LAV63850	LAV BUSE M1/8 40-055	40°	D 055	0.01
LAV63860	LAV BUSE M1/8 40-060	40°	D 060	0.01
LAV63870	LAV BUSE M1/8 40-065	40°	D 065	0.01
LAV63880	LAV BUSE M1/8 40-070	40°	D 070	0.01
LAV63890	LAV BUSE M1/8 40-075	40°	D 075	0.01
LAV63900	LAV BUSE M1/8 40-080	40°	D 080	0.01
LAV63920	LAV BUSE M1/8 40-090	40°	D 090	0.01
LAV63930	LAV BUSE M1/8 40-100	40°	D 100	0.01

Buse pastille - jet droit angle 0°, 15°, 25° et 40°

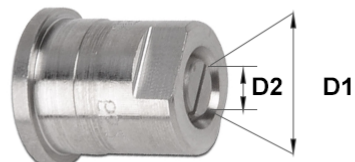

Buse pastille - jet droit angle 0°, 15°, 25° et 40°

Matière : inox

Code	Référence	D1	D2	Poids
0°				
LAV60005	LAV BUSE PASTILLE 00-030	0°	D 030	0.01
LAV60010	LAV BUSE PASTILLE 00-040	0°	D 040	0.01
LAV60020	LAV BUSE PASTILLE 00-045	0°	D 045	0.01
LAV60030	LAV BUSE PASTILLE 00-050	0°	D 050	0.01
LAV60040	LAV BUSE PASTILLE 00-055	0°	D 055	0.01
LAV60050	LAV BUSE PASTILLE 00-060	0°	D 060	0.01
LAV60060	LAV BUSE PASTILLE 00-065	0°	D 065	0.01
LAV60070	LAV BUSE PASTILLE 00-070	0°	D 070	0.01
LAV60075	LAV BUSE PASTILLE 00-075	0°	D 075	0.01
LAV60080	LAV BUSE PASTILLE 00-080	0°	D 080	0.01
LAV60090	LAV BUSE PASTILLE 00-085	0°	D 085	0.01
LAV60100	LAV BUSE PASTILLE 00-090	0°	D 090	0.01
LAV60110	LAV BUSE PASTILLE 00-100	0°	D 100	0.01
LAV60130	LAV BUSE PASTILLE 00-130	0°	D 130	0.01
LAV60140	LAV BUSE PASTILLE 00-150	0°	D 150	0.01
LAV60150	LAV BUSE PASTILLE 00-200	0°	D 200	0.01
LAV60002	LAV BUSE PASTILLE 00-020	0°	D 020	0
15°				
LAV60240	LAV BUSE PASTILLE 15-020	15°	D 020	0
LAV60245	LAV BUSE PASTILLE 15-025	15°	D 025	0
LAV60250	LAV BUSE PASTILLE 15-030	15°	D 030	0
LAV60255	LAV BUSE PASTILLE 15-034	15°	D 034	0
LAV60260	LAV BUSE PASTILLE 15-040	15°	D 040	0
LAV60270	LAV BUSE PASTILLE 15-045	15°	D 045	0
LAV60280	LAV BUSE PASTILLE 15-050	15°	D 050	0
LAV60290	LAV BUSE PASTILLE 15-055	15°	D 055	0
LAV60300	LAV BUSE PASTILLE 15-060	15°	D 060	0
LAV60310	LAV BUSE PASTILLE 15-065	15°	D 065	0
LAV60320	LAV BUSE PASTILLE 15-070	15°	D 070	0
LAV60325	LAV BUSE PASTILLE 15-075	15°	D 075	0
LAV60330	LAV BUSE PASTILLE 15-080	15°	D 080	0
LAV60340	LAV BUSE PASTILLE 15-085	15°	D 085	0
LAV60350	LAV BUSE PASTILLE 15-090	15°	D 090	0
LAV60360	LAV BUSE PASTILLE 15-100	15°	D 100	0
LAV60370	LAV BUSE PASTILLE 15-120	15°	D 120	0
LAV60380	LAV BUSE PASTILLE 15-130	15°	D 130	0
LAV60390	LAV BUSE PASTILLE 15-150	15°	D 150	0
25°				

Code	Référence	D1	D2	Poids
LAV60490	LAV BUSE PASTILLE 25-020	25°	D 020	0
LAV60495	LAV BUSE PASTILLE 25-025	25°	D 025	0
LAV60500	LAV BUSE PASTILLE 25-030	25°	D 030	0.01
LAV60505	LAV BUSE PASTILLE 25-035	25°	D 035	0.01
LAV60510	LAV BUSE PASTILLE 25-040	25°	D 040	0.01
LAV60520	LAV BUSE PASTILLE 25-045	25°	D 045	0.01
LAV60530	LAV BUSE PASTILLE 25-050	25°	D 050	0.01
LAV60540	LAV BUSE PASTILLE 25-055	25°	D 055	0.01
LAV60550	LAV BUSE PASTILLE 25-060	25°	D 060	0.01
LAV60560	LAV BUSE PASTILLE 25-065	25°	D 065	0.01
LAV60570	LAV BUSE PASTILLE 25-070	25°	D 070	0.01
LAV60575	LAV BUSE PASTILLE 25-075	25°	D 075	0.01
LAV60580	LAV BUSE PASTILLE 25-080	25°	D 08	0.01
LAV60590	LAV BUSE PASTILLE 25-085	25°	D 085	0.01
LAV60600	LAV BUSE PASTILLE 25-090	25°	D 090	0.01
LAV60610	LAV BUSE PASTILLE 25-100	25°	D 100	0.01
LAV60620	LAV BUSE PASTILLE 25-120	25°	D 120	0.01
LAV60630	LAV BUSE PASTILLE 25-130	25°	D 130	0.01
LAV60640	LAV BUSE PASTILLE 25-150	25°	D 150	0.01
LAV60650	LAV BUSE PASTILLE 25-200	25°	D 200	0.01
40°				
LAV60750	LAV BUSE PASTILLE 40-030	40°	D 030	0.01
LAV60755	LAV BUSE PASTILLE 40-035	40°	D 035	0.01
LAV60760	LAV BUSE PASTILLE 40-040	40°	D 040	0.01
LAV60770	LAV BUSE PASTILLE 40-045	40°	D 045	0.01
LAV60780	LAV BUSE PASTILLE 40-050	40°	D 050	0.01
LAV60790	LAV BUSE PASTILLE 40-055	40°	D 055	0.01
LAV60800	LAV BUSE PASTILLE 40-060	40°	D 060	0.01
LAV60810	LAV BUSE PASTILLE 40-065	40°	D 065	0.01
LAV60820	LAV BUSE PASTILLE 40-070	40°	D 070	0.01
LAV60825	LAV BUSE PASTILLE 40-075	40°	D 075	0.01
LAV60830	LAV BUSE PASTILLE 40-080	40°	D 08	0.01
LAV60840	LAV BUSE PASTILLE 40-090	40°	D 090	0.01
LAV60860	LAV BUSE PASTILLE 40-100	40°	D 100	0.01
LAV60866	LAV BUSE PASTILLE 40-120	40°	D 120	0.01
LAV60870	LAV BUSE PASTILLE 40-130	40°	D 130	0.01
LAV60880	LAV BUSE PASTILLE 40-150	40°	D 150	0.01
LAV60900	LAV BUSE PASTILLE 40-200	40°	D 200	0.01

Rotabuse avec rotor céramique 150 bars



Rotabuse avec rotor céramique 150 bars

Pression max : 50 à 150 bars

Température : 60°C Max

D2 : Calibre

Code	Référence	D1	D2	Poids
LAV653325	LAV ROTABUSE F1/4 150B-025	FEM 1/4	D 025	0.02
LAV653330	LAV ROTABUSE F1/4 150B-030	FEM 1/4	D 030	0.18
LAV653335	LAV ROTABUSE F1/4 150B-035	FEM 1/4	D 035	0.18
LAV653340	LAV ROTABUSE F1/4 150B-040	FEM 1/4	D 040	0.17
LAV653345	LAV ROTABUSE F1/4 150B-045	FEM 1/4	D 045	0.18

Rotabuse avec rotor céramique 250 bars



Rotabuse avec rotor céramique 250 bars

Pression max : 100 à 250 bars

Température : 100°C

D2 : Calibre

Code	Référence	D1	D2	Poids
LAV200357530	LAV ROTABUSE F1/4 250B-030	FEM 1/4	D 030	0.3
LAV200357535	LAV ROTABUSE F1/4 250B-035	FEM 1/4	D 035	0.3
LAV200357540	LAV ROTABUSE F1/4 250B-040	FEM 1/4	D 040	0.3
LAV200357545	LAV ROTABUSE F1/4 250B-045	FEM 1/4	D 045	0.28
LAV200357550	LAV ROTABUSE F1/4 250B-050	FEM 1/4	D 050	0.3
LAV200357555	LAV ROTABUSE F1/4 250B-055	FEM 1/4	D 055	0.3
LAV200357560	LAV ROTABUSE F1/4 250B-060	FEM 1/4	D 060	0.3
LAV200357565	LAV ROTABUSE F1/4 250B-065	FEM 1/4	D 065	0.28
LAV200357570	LAV ROTABUSE F1/4 250B-070	FEM 1/4	D 070	0.3
LAV200357580	LAV ROTABUSE F1/4 250B-080	FEM 1/4	D 080	0.3
LAV200357690	LAV ROTABUSE F1/4 250B-090	FEM 1/4	D 090	0.3
LAV200357510	LAV ROTABUSE F1/4 250B-100	FEM 1/4	D 100	0.3

Rotabuse avec rotor céramique 400 bars



Rotabuse avec rotor céramique 400 bars

Pression max : 200 à 400 bars
Température : 100°C

Code	Référence	D1	D2	Poids
LAV200458630	LAV ROTABUSE F1/4 400B-030	FEM 1/4	D 030	0.68
LAV200458635	LAV ROTABUSE F1/4 400B-035	FEM 1/4	D 035	0.68
LAV200458640	LAV ROTABUSE F1/4 400B-040	FEM 1/4	D 040	0.68
LAV200458645	LAV ROTABUSE F1/4 400B-045	FEM 1/4	D 045	0.68
LAV200458650	LAV ROTABUSE F1/4 400B-050	FEM 1/4	D 050	0.68
LAV200458655	LAV ROTABUSE F1/4 400B-055	FEM 1/4	D 055	0.68
LAV200458660	LAV ROTABUSE F1/4 400B-060	FEM 1/4	D 060	0.68
LAV200458665	LAV ROTABUSE F1/4 400B-065	FEM 1/4	D 065	0.68
LAV200458670	LAV ROTABUSE F1/4 400B-070	FEM 1/4	D 070	0.68
LAV200458680	LAV ROTABUSE F1/4 400B-080	FEM 1/4	D 080	0.68
LAV200458690	LAV ROTABUSE F1/4 400B-090	FEM 1/4	D 090	0.68
LAV200458610	LAV ROTABUSE F1/4 400B-100	FEM 1/4	D 100	0.68
LAV200458811	LAV ROTABUSE F1/4 400B-110	FEM 1/4	D 110	0.7
LAV200458812	LAV ROTABUSE F1/4 400B-120	FEM 1/4	D 120	0.67
LAV200458815	LAV ROTABUSE F1/4 400B-150	FEM 1/4	D 150	0.67
LAV200458820	LAV ROTABUSE F1/4 400B-200	FEM 1/4	D 200	0.75
LAV200458825	LAV ROTABUSE F1/4 400B-250	FEM 1/4	D 250	0.77
LAV200458830	LAV ROTABUSE F1/4 400B-300	FEM 1/4	D 300	0.77

Buse multiréglage

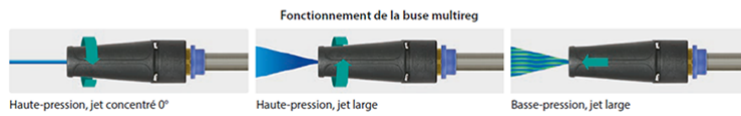

Buse multiréglage

Pression : 200 bars
Température : 150°C maximum

Code	Référence	D1	D2	Poids
LAV6581030	LAV BUSE MULTIREG F1/4-030	FEM 1/4	D 030	0
LAV6581035	LAV BUSE MULTIREG F1/4-035	FEM 1/4	D 035	0.17
LAV6581045	LAV BUSE MULTIREG F1/4-045	FEM 1/4	D 045	0.17
LAV6581040	LAV BUSE MULTIREG F1/4-040	FEM 1/4	D 040	0.17
LAV658105	LAV BUSE MULTIREG F1/4-050	FEM 1/4	D 050	0.16
LAV6581055	LAV BUSE MULTIREG F1/4-055	FEM 1/4	D 055	0.16
LAV658106	LAV BUSE MULTIREG F1/4-060	FEM 1/4	D 060	0.16

Buse 3 positions



Buse 3 positions

Pression max : 250 bars
Température : 80°C maxi

Code	Référence	D1	D2	Poids
LAV657545	LAV BUSE 3 POSITIONS F1/4-045	FEM 1/4	D 045	0.22
LAV657555	LAV BUSE 3 POSITIONS F1/4-055	FEM 1/4	D 055	0.22
LAV657560	LAV BUSE 3 POSITIONS F1/4-060	FEM 1/4	D 060	0.22

Buse de canalisation fixe sans jet frontal calibre femelle 1/4



Buse de canalisation fixe sans jet frontal calibre femelle 1/4

Femelle 1/4
Diamètre 19mm

Code	Référence	D1	D2	Poids
LAV65105	LAV BUSE CANALISATION F1/4 FSF-035	FEM 1/4	D 035	0.02
LAV65104	LAV BUSE CANALISATION F1/4 FSF-040	FEM 1/4	D 040	0.02
LAV65100	LAV BUSE CANALISATION F1/4 FSF-045	FEM 1/4	D 045	0.02
LAV65108	LAV BUSE CANALISATION F1/4 FSF-050	FEM 1/4	D 050	0.02
LAV65116	LAV BUSE CANALISATION F1/4 FSF-055	FEM 1/4	D 055	0.02
LAV65110	LAV BUSE CANALISATION F1/4 FSF-060	FEM 1/4	D 060	0.02
LAV65140	LAV BUSE CANALISATION F1/4 FSF-090	FEM 1/4	D 090	0.02
LAV65148	LAV BUSE CANALISATION F1/4 FSF-120	FEM 1/4	D 120	0

Buse de canalisation fixe avec jet frontal calibre femelle 1/4



Buse de canalisation fixe sans jet frontal calibre femelle 1/4

Matière : inox
Femelle 1/4 - Diamètre 19mm

Code	Référence	D1	D2	Poids
LAV65114	LAV BUSE CANALISATION F1/4 FAF-040	FEM 1/4	D 040	0.02
LAV65112	LAV BUSE CANALISATION F1/4 FAF-045	FEM 1/4	D 045	0.02
LAV65113	LAV BUSE CANALISATION F1/4 FAF-050	FEM 1/4	D 050	0.02
LAV65115	LAV BUSE CANALISATION F1/4 FAF-055	FEM 1/4	D 055	0.02
LAV65118	LAV BUSE CANALISATION F1/4 FAF-060	FEM 1/4	D 060	0.02
LAV65120	LAV BUSE CANALISATION F1/4 FAF-075	FEM 1/4	D 075	0.02
LAV65125	LAV BUSE CANALISATION F1/4 FAF-090	FEM 1/4	D 090	0
LAV65130	LAV BUSE CANALISATION F1/4 FAF-100	FEM 1/4	D 100	0.02
LAV65146	LAV BUSE CANALISATION F1/4 FAF-110	FEM 1/4	D 110	0

Buse de canalisation fixe avec jet frontal calibre femelle 1/8



Buse de canalisation fixe sans jet frontal calibre femelle 1/8

Matière : inox
Femelle 1/8 - Diamètre 15mm

Code	Référence	D1	D2	Poids
LAV65020	LAV BUSE CANALISATION F1/8 FAF-075	FEM 1/8	D 075	0
LAV122370170	LAV BUSE CANALISATION F1/8 FAF-040	FEM 1/8	D 040	0.01
LAV122370180	LAV BUSE CANALISATION F1/8 FAF-045	FEM 1/8	D 045	0
LAV65060	LAV BUSE CANALISATION F1/8 FAF-050	FEM 1/8	D 050	0.01
LAV65050	LAV BUSE CANALISATION F1/8 FAF-055	FEM 1/8	D 055	0.01
LAV65055	LAV BUSE CANALISATION F1/8 FAF-060	FEM 1/8	D 060	0.01
LAV65056	LAV BUSE CANALISATION F1/8 FAF-065	FEM 1/8	D 065	0.01

6- ENROULEUR AUTOMATIQUE



Enrouleur automatique haute-pression HP/2

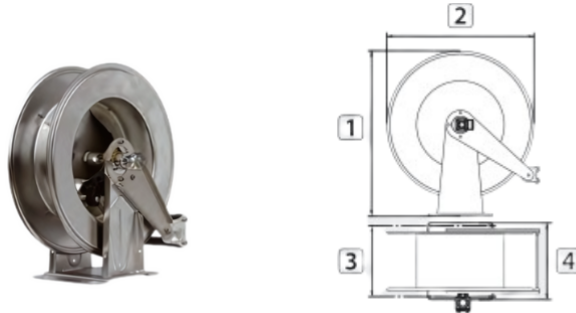

Enrouleur automatique haute-pression HP/2

Matière : Acier inoxydable 304

Température : 150°C max

Pression de service : 100 à 300 bars

Enrouleur vendu sans le tuyau, possibilité de l'équiper sur demande au choix en supplément

Capacité : 21M --> Tuyau ø extérieur 17,0mm

16M --> Tuyau ø extérieur 19,5mm

14M --> Tuyau ø extérieur 22,0mm

Code	Référence	F1	F2	D1 (mm)	D2 (mm)	D3 (mm)	Poids
LAV76343430	LAV ENROULEUR HP/2 INOX DN13-16M	FEM 1/2"	FEM 1/2"	460	420	140	0

Enrouleur automatique haute-pression HP/4

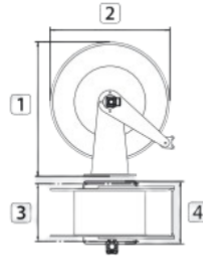

Enrouleur automatique haute-pression HP/4

Matière : Acier inoxydable 304

Température : 150°C max

Pression de service : 100-300 bars

Enrouleur vendu sans le tuyau, possibilité de l'équiper sur demande au choix en supplément

Capacité : 28M --> Tuyau ø extérieur 18,5mm

26M --> Tuyau ø extérieur 20mm

24M --> Tuyau ø extérieur 22,0mm

Code	Référence	F1	F2	D1 (mm)	D2 (mm)	D3 (mm)	Poids
LAV76353430	LAV ENROULEUR HP/4 INOX DN13-26M	FEM 1/2"	FEM 1/2"	560	510	153	19

Enrouleur automatique haute-pression HP/6

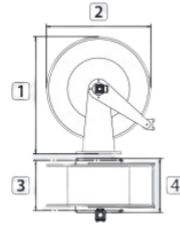

Enrouleur automatique haute-pression HP/6

Matière : Acier inoxydable 304

Température : 150°C max

Pression de service : 100 à 300 bars

Enrouleur vendu sans le tuyau, possibilité de l'équiper sur demande au choix en supplément

Capacité : 30M --> Tuyau ø extérieur 22,0mm

22M --> Tuyau ø extérieur 28,0mm

17M --> Tuyau ø extérieur 34,0mm

Code	Référence	F1	F2	D1 (mm)	D2 (mm)	D3 (mm)	Poids
LAV76354430	LAV ENROULEUR HP/6 INOX DN13-36M	FEM 1/2"	FEM 1/2"	573	510	218	0

Enrouleur automatique haute-pression HP/8

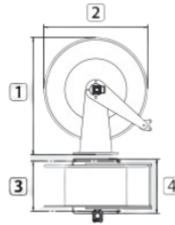

Enrouleur automatique haute-pression HP/8

Matière : Acier inoxydable 304

Température : 150°C max

Pression de service : 100 à 300 bars

Enrouleur vendu sans le tuyau, possibilité de l'équiper sur demande au choix en supplément

Capacité : 60M --> Tuyau ø extérieur 22,0mm

40M --> Tuyau ø extérieur 30,0mm

30M --> Tuyau ø extérieur 35,0mm

Code	Référence	F1	F2	D1 (mm)	D2 (mm)	D3 (mm)	Poids
LAV76356430	LAV ENROULEUR HP/8 INOX DN13-70M	FEM 1/2"	FEM 1/2"	560	510	153	0

Enrouleur automatique haute pression en acier thermolaqué

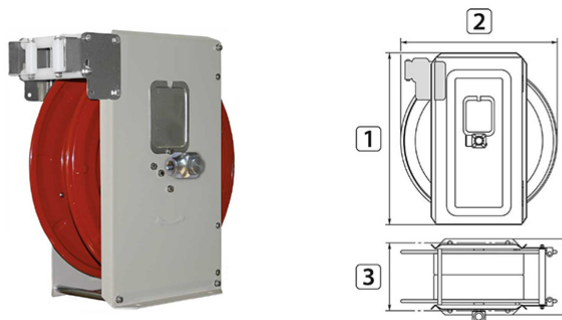

Enrouleur automatique haute pression en acier thermolaqué

Type HP1/1 - HP/2 - HP/3

Acier thermolaqué : à utiliser dans un environnement abrité

Température : 90 °C max

Pression max :

pour version FEM 3/8 = 400 bars

pour version FEM 3/4 = 200 bars

Possibilité de raccordement male 22x150 sur demande

Enrouleur vendu sans le tuyau, possibilité de l'équiper sur demande au choix en supplément

Code	Référence	F1	F2	D1 (mm)	D2 (mm)	D3 (mm)	Poids
LAV75014	LAV ENROULEUR HP/1 ACIER DN10-14M	FEM 3/8	FEM 3/8	440	400	176	14
LAV75020	LAV ENROULEUR HP/1 ACIER DN10-20M	FEM 3/8	FEM 3/8	500	460	176	17.5
LAV75030	LAV ENROULEUR HP/3 ACIER DN10-30M	FEM 3/8	FEM 3/8	500	460	226	19
LAV75040	LAV ENROULEUR HP/3 ACIER DN10-40M	FEM 3/8	FEM 3/8	500	460	276	23
LAV7502019	LAV ENROULEUR HP/1 ACIER DN19-10M	FEM 3/4	FEM 3/4	500	460	176	16.5
LAV7504019	LAV ENROULEUR HP/5 ACIER DN19-36M	FEM 3/4	FEM 3/4	500	460	376	26.5

Enrouleur automatique haute pression en inox

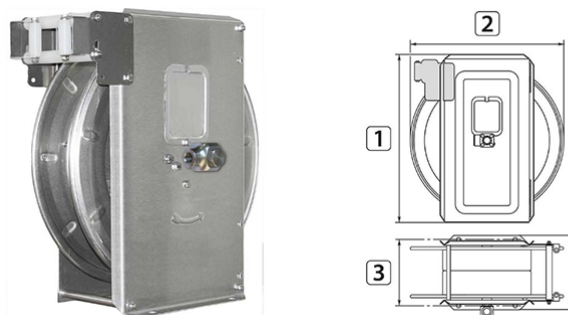

Enrouleur automatique haute pression en inox

Type HP/1 - HP/3 - HP/5

Matière : Acier inoxydable 304

Utilisation dans un environnement non abrité

Température : 90°C max

pour version FEM 3/8 = 400 bars

pour version FEM 1/2 = 300 bars

pour version FEM 3/4 = 200 bars

Possibilité de raccordement male 22x150 sur demande

Enrouleur vendu sans le tuyau, possibilité de l'équiper sur demande au choix en supplément

Code	Référence	F1	F2	D1 (mm)	D2 (mm)	D3 (mm)	Poids
LAV74014	LAV ENROULEUR HP/1 INOX DN10-14M	FEM 3/8	FEM 3/8	440	400	176	12.7
LAV74020	LAV ENROULEUR HP/1 INOX DN10-20M	FEM 3/8	FEM 3/8	500	460	176	16
LAV74030	LAV ENROULEUR HP/3 INOX DN10-30M	FEM 3/8	FEM 3/8	500	460	226	18
LAV74040	LAV ENROULEUR HP/3 INOX DN10-40M	FEM 3/8	FEM 3/8	500	460	276	22.3
LAV74060	LAV ENROULEUR HP/5 INOX DN10-57M	FEM 3/8	FEM 3/8	500	460	376	28.5
LAV740312	LAV ENROULEUR HP/3 INOX DN12-25M	FEM 1/2	FEM 1/2	500	460	226	0
LAV7402012	LAV ENROULEUR HP/1 INOX DN13-17M	FEM 3/8	FEM 3/8	500	460	716	16
LAV7404012	LAV ENROULEUR HP/3 INOX DN13-36M	FEM 3/4	FEM 3/4	500	460	176	16
LAV7404019	LAV ENROULEUR HP/5 INOX DN19-36M	FEM 3/4	FEM 3/4	500	460	376	26.5

Consoles murales orientables 80° TYPE HP/2 - HP/4 et HP/6



Consoles murales orientables 80° TYPE HP/2 - HP/4 et HP/6

Matière : Inox AISI 304
Orientable 80°

Code	Référence	F1	F2	D1 (mm)	D2 (mm)	D3 (mm)	Poids
LAV76343006	LAV CONSOLE INOX ENROULEUR HP/2						0
LAV76353006	LAV CONSOLE INOX ENROULEUR HP/4						0
LAV76354006	LAV CONSOLE INOX ENROULEUR HP/6						0

Consoles murales orientables 180° TYPE HP/1 - HP/3 et HP/5



HP/1



HP/3 ET /5

Consoles murales orientables 180° TYPE HP/1 - HP/3 et HP/5

Matière : Inox AISI 304
Orientable 180°

Code	Référence	F1	F2	D1 (mm)	D2 (mm)	D3 (mm)	Poids
LAV74100	LAV CONSOLE ACIER ENROULEUR HP/1						0
LAV741001	LAV CONSOLE ACIER ENROULEUR HP/3						0
LAV741003	LAV CONSOLE ACIER ENROULEUR HP/5						0

Platines de fixation intermédiaire



Platines de fixation intermédiaire

Matière : Inox AISI 304
En option : montage simplifié

Code	Référence	F1	F2	D1 (mm)	D2 (mm)	D3 (mm)	Poids
LAV76343002	LAV PLATINE INOX ENROULEUR HP/2						0
LAV76353002	LAV PLATINE INOX ENROULEUR HP/4						0
LAV76354002	LAV PLATINE INOX ENROULEUR HP/6						0
LAV76356002	LAV PLATINE INOX ENROULEUR HP/8						0

7- COUPLEUR EAU HAUTE PRESSION

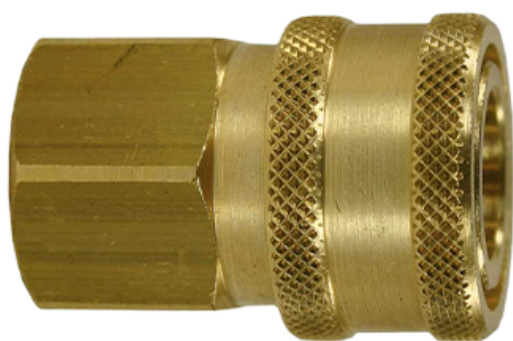

Coupleur rapide ST-45-250 KW

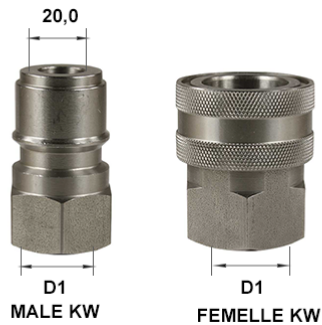

Coupleur rapide ST-45-250 KW

Matière : Acier / Inox / laiton
Pression max : 250 bars
Température : 150°C maximum
Diamètre : 20

Code	Référence	D1	D2	Poids
FEMELLE INOX				
LAV200045570	LAV CPL INOX FKWXFG1/4	FEM 1/4	INOX	0.16
LAV200045575	LAV CPL INOX FKWXM22F	FEM22X150	INOX	0
LAV200045560	LAV CPL INOX FKWXFG3/8	FEM 3/8	INOX	0.17
LAV200045550	LAV CPL INOX FKWXFG1/2	FEM 1/2	INOX	0.14
FEMELLE LAITON				
LAV200045510	LAV CPL LAIT FKWXFG3/8	FEM 3/8	LAITON	0.13
MALE ACIER				
LAV557205	LAV CPL ACIER M22F	FEM22X150	ACIER	0
LAV557204	LAV CPL ACIER MKWXFG3/8	FEM 3/8	ACIER	0.06
MALE INOX				
LAV040005482	LAV CPL INOX MKWXFG1/4 DURCI	FEM 1/4	INOX	0.05
LAV557209	LAV CPL INOX MKWXFG3/8	FEM 3/8	INOX	0.05
LAV55729	LAV CPL INOX MKWXFG1/2	FEM 1/2	INOX	0.08

Coupleur rapide type SP20



MALE



FEMELLE



<p>Coupleur rapide type SP20</p> <p>Matière : Laiton / Acier Pression max : 250 bars Température : 100°C maximum Diamètre : 14,8mm</p>				
--	--	--	--	--

Code	Référence	D1	D2	Poids
MALE				
LAV55111	LAV CPL ACIER M SP20XFG1/4	FEM 1/4	ACIER	0.04
LAV55110	LAV CPL ACIER M SP20XFG3/8	FEM 3/8	ACIER	0.01
LAV55120	LAV CPL ACIER M SP20XMG3/8	MALE 3/8	ACIER	0
FEMELLE				
LAV55010	LAV CPL LAIT F SP20XFG3/8	FEM 3/8	LAITON	0.12
LAV55020	LAV CPL LAIT F SP20XMG3/8	MALE 3/8	LAITON	0.09
LAV55030	LAV CPL LAIT F SP20XFG1/2	FEM 1/2	LAITON	0.12
JOINT				
LAV79060	JOINT TORIQUE ST-20	13.1x2.62		0

Coupleur rapide inox type ST3100

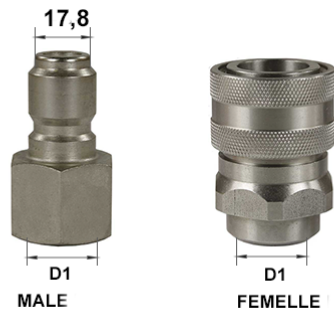

Coupleur rapide inox type ST3100

Matière : Inox
Pression max : 250 bars
Température : 150°C maximum
Diamètre : 20

Code	Référence	D1	D2	Poids
FEMELLE				
LAV203100456	LAV CPL INOX F ST3100XFG3/8 PVC	FEM 3/8	INOX	0
LAV203100474	LAV CPL INOX F ST3100XMBSP3/8	MALE BSP 3/8	INOX	0
LAV203100466	LAV CPL INOX F ST3100XFG1/4	FEM 1/4	INOX	0.15
LAV203100461	LAV CPL INOX F ST3100XFG3/8	FEM 3/8	INOX	0.14
LAV203100460	LAV CPL INOX F ST3100XFG1/2	FEM 1/2	INOX	0.12
LAV203100655	LAV CPL INOX F ST3100XMBSP1/2	MALE 1/2 BSP	INOX	0.13
LAV203100656	LAV CPL INOX F ST3100XMBSP1/2 PVC	MALE 1/2 BSP	INOX	0
INOX				
LAV040005459	LAV CPL INOX-DURCI M ST3100XMBSP3/8	MALE 3/8 BSP	INOX - DURCI	0
LAV040005462	LAV CPL INOX-DURCI M ST3100XMBSP1/2	MALE 1/2 BSP	INOX - DURCI	0
MALE				
LAV203100455	LAV CPL INOX F ST3100XFG1/2 PVC	FEM 1/2	INOX	0
LAV040005465	LAV CPL INOX-DURCI M ST3100XFG1/4	FEM 1/4	INOX - DURCI	0
LAV040005665	LAV CPL INOX M ST3100XFG1/4	FEM 1/4	INOX	0.04
LAV040005667	LAV CPL INOX M ST3100XFG3/8	FEM 3/8	INOX	0.06
LAV040005661	LAV CPL INOX M ST3100XFG1/2	FEM 1/2	INOX	0.09
LAV040005668	LAV CPL INOX M ST3100XMBSP3/8	MALE 3/8 BSP	INOX	0.06
LAV040005662	LAV CPL INOX M ST3100XMBSP1/2	MALE 1/2 BSP	INOX	0.06

Coupleur rapide inox type ST600 femelle et male

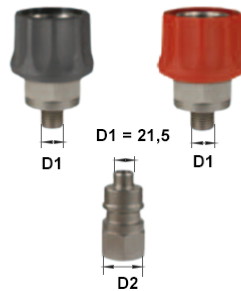

Coupleur rapide inox type ST600 femelle et male

Matière : Inox
Pression max : 600 bars
Température : 150°C maximum

Code	Référence	D1	D2	Poids
FEMELLE				
LAV200045600	LAV CPL INOX F ST600XMG1/4 NOIR	MALE 1/4	INOX	0.22
LAV200045605	LAV CPL INOX F ST600XMG1/4 ROUGE	MALE 1/4	INOX	0.21
JOINT TORIQUE				
LAV050000020	LAV JOINT TORIQUE 11X1.5	11x1.5	CAOUTCHOUC	0
LAV050000160	LAV JOINT TORIQUE 10X2.5	10x2.5	CAOUTCHOUC	0
MALE				
LAV040005468	LAV CPL INOX M ST600XFG1/4	FEM 1/4	INOX	0.07

Coupleur rapide type KW/P

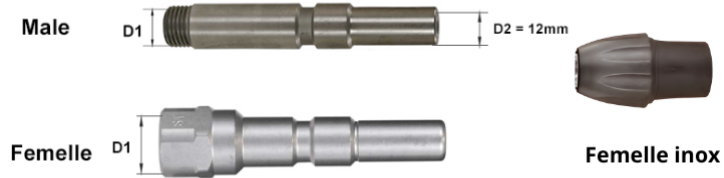

Coupleur rapide type KW/P

Matière : Inox
Pression max : 250 bars
Température : 150°C maximum
Diamètre 20.0

Code	Référence	D1	D2	Poids
FEMELLE INOX				
LAV202700350	LAV CPL INOX FKW/PXMG1/4	MALE 1/4"	FEM INOX	0
LAV202700301	LAV CPL INOX FKW/PXFG1/4	FEM 1/4	FEM INOX	0
FEMELLE LAITON				
LAV55926	LAV CPL LAIT FKW/PXMG1/4	MALE 1/4	FEM LAITON	0
LAV202300301	LAV CPL LAIT FKW/PXFG1/4	FEM 1/4	FEM LAITON	0
MALE INOX				
LAV040001255	LAV CPL INOX MKW/PXFG1/4	FEM 1/4	MALE INOX	0.08
LAV040001256	LAV CPL INOX MKW/PXMG1/4	MALE 1/4	MALE INOX	0.07

8- RACCORD TOURNANT SOUS PRESSION



Coude tournant tout inox



Coude tournant tout inox

Pression max : 400 bars
Température : 90°C
30 tour/min

Code	Référence	D1	D2	Poids
LAV200320550	LAV COUDE TOURNANT 400B M1/4XF1/4	MALE 1/4	FEM 1/4	0.18
LAV200320500	LAV COUDE TOURNANT 400B M3/8XF3/8	MALE 3/8	FEM 3/8	0.17

Raccord tournant laiton

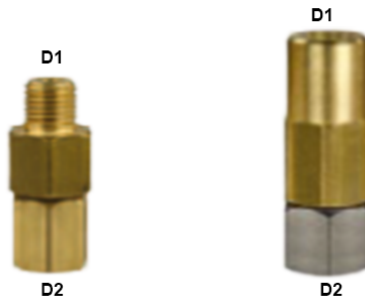

Raccord tournant laiton

Matière : laiton
Pression max : 220 bars
Température : 90°C

Code	Référence	D1	D2	Poids
LAV200300010	LAV RACC TOURNANT 220B M3/8XF3/8	MALE 3/8	FEM 3/8	0.1
LAV200300050	LAV RACC TOURNANT 220B F3/8XF1/4	FEM 3/8	FEM 1/4	0.11
LAV200340510	LAV RACC TOURNANT 220B M1/2XF1/2	MALE 1/2	FEM 1/2	0.11

Raccord tournant inox

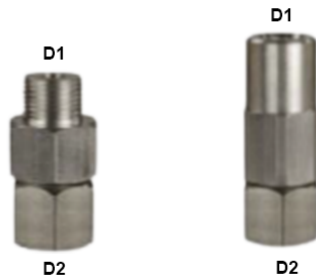

Raccord tournant inox

Matière : inox
Pression max : 350 bars
Température : 90°C

Code	Référence	D1	D2	Poids
LAV200310000	LAV RACC TOURNANT 350B F3/8XF1/4	FEM 3/8	FEM 1/4	0.1
LAV200310010	LAV RACC TOURNANT 350B M3/8XF3/8	MALE 3/8	FEM 3/8	0.1
LAV200310040	LAV RACC TOURNANT 350B M1/2XF1/2	MALE 1/2	FEM 1/2	0.12

Coude tournant pour enrouleurs

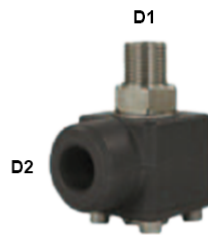

Coude tournant pour enrouleurs

Matière : inox/acier
Pression max : 300 bars
Température : 90°C

Code	Référence	D1	D2	Poids
LAV7502001	LAV COUDE TOURNANT 300B M3/8XF3/8	MALE 3/8	FEM 3/8	0.23
LAV7504012	LAV COUDE TOURNANT 300B M3/8XF1/2	MALE 3/8	FEM 1/2	0.19

Coude tournant corps et moyeu inox

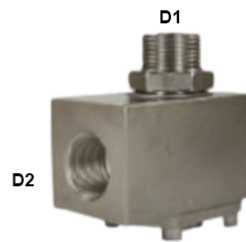

Coude tournant corps et moyeu inox

Matière : inox
Pression max : 200 bars
Température : 90°C

Code	Référence	D1	D2	Poids
LAV7504001	LAV COUDE TOURNANT 200B M3/4XF3/4	MALE 3/4	FEM 3/4	1.08

9- ACCESSOIRES DE LAVAGE



Brosse rotative femelle 1/4 orientable



Brosse rotative femelle 1/4 orientable

Brosse en crin de cheval
Brosse avec articulation
Pression Max : 50 bar
Température : 50°C

Code	Référence	D1	D2	Poids
BROSSE COMPLETE				
LAV52250	LAV BROSSE ROT ORIENTABLE F1/4 CRIN	FEM 1/4		0.84
LAV52260	LAV BROSSE ROT ORIENTABLE F1/4 NYLON	FEM 1/4		0.86
ELEMENT BROSSE				
LAV52410	LAV ELEMENT BROSSE ROT CRIN			0.31
LAV52420	LAV ELEMENT BROSSE ROT NYLON			0.35

Lance télescopique et brosse de lavage



Lance télescopique et brosse de lavage

Poils souples
Marque : R+M Sutter GMBH

Code	Référence	D1	D2	Poids
LAV52500010	LAV BROSSE BP SOUPLE POUR LANCE TELE	SOUPLE	250X80mm	0.42
LAV52501010	LAV BROSSE BP DURE POUR LANCE TELE	DUR	250X80mm	0
LANCE				
LAV52505010	LAV MANCHE TELESCOPIQUE BP 1020-1800	1020-1800mm	SS PASSAGE EAU	0
LAV52507010	LAV MANCHE TELESCOPIQUE BP 1920-3600	1920-3600mm	SS PASSAGE EAU	0
LAV52530010	LAV MANCHE TELESCOPIQUE BP 1500-3500	1500-3500mm	AV PASSAGE EAU	0

Articulation pour lance telescopique



Articulation pour lance telescopique

Filetage spiralé

Articulation pivotante pour lances telescopiques avec filetage cordelé

Code	Référence	D1	D2	Poids
LAV525040	LAV ARTICULATION LANCE TELESCOPIQUE			0.07
LAV52504010	LAV ARTICULATION LANCE TELESCOPIQUE			0.07

Support murale pour tuyau



Support murale pour tuyau

D1 : dimension

D2 : matière

Code	Référence	D1	D2	Poids
LAV11000	LAV SUPPORT TUYAU PVC	260X165X170	PVC	0.25
LAV11005	LAV SUPPORT TUYAU ACIER	280X130X140	ACIER LAQUE	0
LAV11006	LAV SUPPORT TUYAU INOX	350X155X195	INOX	0.95

Pulvérisateurs manuels type mini et industry



Version industry

Pulvérisateurs manuels type mini et industry

D2 : litrage
Capacité 0,5/1 litre

Version industry : équipé d'une base de précision avec jet réglable et d'un filtre intégré dans le tube d'aspiration

Fonctionne également tête inversé

Code	Référence	D1	D2	Poids
LAV106995005	LAV PULVERISATEUR 0.5 LITRE	JOINT NBR	0.5L	0.07
LAV106995010	LAV PULVERISATEUR 1 LITRE	JOINT NBR	1L	0.12
INDUSTRY				
LAV106995015	LAV PULVERISATEUR 1.5 LITRES	JOINT VITON	1.5L	0
LAV106995020	LAV PULVERISATEUR 2 LITRES	JOINT VITON	2.0L	0

Pulvérisateurs manuels type industrie



Pulvérisateurs manuels type industrie

Compatible avec la plupart des produits chimiques employés
Joint EPDM (Viton sur demande)

Utilisation : Stations de lavage, plateformes de forage

D1 : dimension

D2 : litrage

Capacité : 7-12 litres

Code	Référence	D1	D2	Poids
LAV106995070	LAV PULVERISATEUR 7 LITRES	470X220mm	7l	2
LAV106995090	LAV PULVERISATEUR 9 LITRES	570X220mm	9l	2.2
LAV106995120	LAV PULVERISATEUR 12 LITRES	600X220mm	12l	2.4

Pistolet à détergents



Lance



Flexible

Pistolet à détergents

Pression Max : 25 bar / 30 l/min
Température : 50°C

Code	Référence	D1	D2	Poids
LAV106995500	LAV LANCE POUR PULVERISATEUR	700-1350mm	TELESCOPIQUE	0
LAV106995501	LAV TUYAU 1.7M POUR PULVERISATEUR	1.7M		0
LAV200510710	LAV PISTOLET A DETERGENTS F1/2 L210	FEM 1/2		0.18
LAV50000	LAV PISTOLET A DETERGENTS F1/2	FEM 1/2		0.13

10- ACCESSOIRE DE JARDINAGE



Coupleur laiton femelle arrosage universel pour TUYAU



Coupleur laiton femelle arrosage universel pour TUYAU

Matière : Laiton
Pression Max : 10 bar
Température : -10°C à +90°C
 Compatible avec tous les systèmes à coupleurs rapides courants
D1 : Femelle 16 sur robinet

Code	Référence	D1	D2	Poids
AVEC CLAPET				
LAV728335	LAV CPL LAIT ARROSAGE F16XD15 CLAPET	NEZ FEM 16	TUYAU 12-15mm	0.12
LAV728336	LAV CPL LAIT ARROSAGE F16XD19 CLAPET	NEZ FEM 16	TUYAU 16-19mm	0.14
SANS CLAPET				
LAV7283305	LAV CPL LAIT ARROSAGE F16XD15	NEZ FEM 16	TUYAU 12-15mm	0
LAV7283315	LAV CPL LAIT ARROSAGE F16XD19	NEZ FEM 16	TUYAU 16-19mm	0

Coupleur laiton robinet arrosage universel



Coupleur laiton robinet arrosage universel

Matière : Laiton
Température : 90°C
Pression Max : 10 Bars

Code	Référence	D1	D2	Poids
		FEMELLE		
LAV728334	LAV CPL LAIT ARROSAGE F16XF3/4	NEZ FEM 16	FEM 3/4	0.1
		MALE		
LAV728333	LAV CPL LAIT ARROSAGE F16XM3/4	NEZ FEM 16	MALE 3/4	0.09

Coupleur robinet arrosage universel



Coupleur robinet arrosage universel

Matière : Laiton - PVC

Pression Max : 10 bar

Température : -10°C à +90°C

Compatible avec tous les systèmes à coupleurs rapides courants

Code	Référence	D1	D2	Poids
FEMELLE LAITON				
LAV728310	LAV CPL LAIT ARROSAGE M16XF1/2	NEZ MALE 16	FEM 1/2	0.04
LAV728311	LAV CPL LAIT ARROSAGE M16XF3/4	NEZ MALE 16	FEM 3/4	0.04
LAV728312	LAV CPL LAIT ARROSAGE M16XF1	NEZ MALE 16	FEM 1"	0
MALE LAITON				
LAV728320	LAV CPL LAITON ARROSAGE M16XM1/2	NEZ MALE 16	MALE 1/2	0
LAV728321	LAV CPL LAIT ARROSAGE M16XM3/4	NEZ MALE 16	MALE 3/4	0.04
PVC				
LAV72700	LAV CPL PVC ARROSAGE M16XF1/2	NEZ MALE 16	FEM 1/2	0.01
LAV72710	LAV CPL PVC ARROSAGE M16XF3/4	NEZ MALE 16	FEM 3/4	0.01
LAV72713	LAV CPL PVC ARROSAGE M16XF1"	NEZ MALE 16	FEM 1"	0

Coupleur laiton femelle arrosage universel MALE/MALE



D1 = D2

Coupleur laiton femelle arrosage universel MALE/MALE

Matière : Laiton

Pression Max : 10 bar

Pression Max : -10°C à +90°C

Pour le raccordement de tuyaux d'eau équipés de coupleurs femelles
Compatible avec tous les systèmes à coupleurs rapides courants

Code	Référence	D1	D2	Poids
LAV728340	LAV CPL LAIT ARROSAGE DOUBLE M16	NEZ MALE 16	NEZ MALE 16	0.05

Accessoires pour coupleur arrosage universel



Accessoires pour coupleur arrosage universel

Température : 80°C
Matériau : NBR

Code	Référence	D1	D2	Poids
LAV72523	LAV JOINT PLAT POUR BP F3/8		FEM 3/8	0
LAV72524	LAV JOINT PLAT POUR BP F1/2		FEM 1/2	0
LAV72525	LAV JOINT PLAT POUR BP F3/4		FEM 3/4	0
LAV72526	LAV JOINT PLAT POUR BP F1"		FEM 1"	0
LAV72527	LAV JOINT PLAT POUR BP F1*1/4		FEM 1*1/4	0
LAV72528	LAV JOINT PLAT POUR BP F1*1/2		FEM 1*1/2	0
TAMIS				
LAV728250	LAV TAMIS F3/4 CPL LAIT ARROSAGE		FEM 3/4	0

Coupleur PVC femelle arrosage universel pour TUYAU



Coupleur PVC femelle arrosage universel pour TUYAU

Matière : PVC

Pression Max : 10 bar

Température : -10°C à +30°C

Compatible avec tous les systèmes à coupleurs rapides courants

Code	Référence	D1	D2	Poids
AVEC CLAPET				
LAV72741	LAV CPL PVC ARROSAGE F16XD15 CLAPET	FEM 16	12-15mm	0.03
LAV72743	LAV CPL PVC ARROSAGE F16XD19 CLAPET	FEM 16	16-19mm	0.04
SANS CLAPET				
LAV72701	LAV CPL PVC ARROSAGE F16XD15	FEM 16	12-15mm	0
LAV72703	LAV CPL PVC ARROSAGE F16XD19	FEM 16	16-19mm	0.04

Pistolet d'arrosage

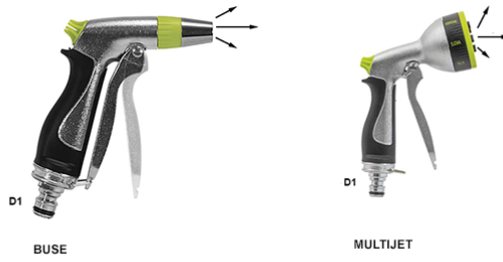

Pistolet d'arrosage

A buse ajustable ou multi jet 7 positions
Pression max : 8 bar
Température max : 20 °C

Code	Référence	D1	D2	Poids
LAV726416	LAV PISTOLET BP CPL BUSE	NEZ MALE 16		0
LAV726419	LAV PISTOLET BP CPL MULTIJET	NEZ MALE 16		0

CONTACT

CIHAL FORBACH : TECHNOPOLE
FORBACH SUD 113 RUE ROBERT
BUNSEN 57460 - BEHREN LÈS
FORBACH, FRANCE

CIHAL ALSACE : 22 RUE HANNAH
ARENDT 67200 STRASBOURG,
FRANCE

PJHY : 1 ALL. DES BONNETONS
54425 - PULNOY FRANCE

POUR TOUTE DEMANDE OU
INFORMATION COMPLÉMENTAIRE,
VEUILLEZ NOUS CONTACTER À
L'ADRESSE MAIL SUIVANTE :
MAGASIN@CIHAL.FR

